

**BYLAW NO. 1242-21**  
**BEING A BYLAW OF**  
**MACKENZIE COUNTY**  
**IN THE PROVINCE OF ALBERTA**

**TO ADOPT THE AREA STRUCTURE PLAN**  
**FOR SW 5-110-13-W5M FOR CARIBOU MOUNTAIN CENTRE**

**WHEREAS**, pursuant to the provisions of the Municipal Government Act, Revised Statutes of Alberta, 2000, Chapter M-26, Section 633 and amendments thereto, Council may adopt an Area Structure Plan;

**WHEREAS**, the Council of Mackenzie County has deemed it desirable to adopt an Area Structure Plan to guide the future development of SW 5-110-13-W5M;

**NOW THEREFORE**, be it resolved that the Council of Mackenzie County duly assembled, hereby enacts as follows:

1. That an Area Structure Plan for a Rural Commercial and Industrial subdivision on SW 5-110-13-WM be adopted as shown in Schedule A hereto attached.

READ a first time this 9<sup>th</sup> day of November, 2021.

PUBLIC HEARING held this 14<sup>th</sup> day of December, 2021

READ a second time this 14<sup>th</sup> day of December, 2021.

READ a third time and finally passed this 14<sup>th</sup> day of December, 2021.

---

Joshua Knelsen  
Reeve

---

Byron Peters  
Interim Chief Administrative Officer

---

---

**SCHEDULE "A"**

**CARIBOU MOUNTAIN CENTER AREA STRUCTURE PLAN  
FOR SW 5-110-13-W5M**

\_\_\_\_\_  
\_\_\_\_\_



# CARIBOU MOUNTAIN COMMERCIAL PARK

## AREA STRUCTURE PLAN

July 23, 2021



## **PREPARED FOR:**

Little Red River Group of Companies LP  
9402 114 Ave  
High Level, AB T0H 1Z0

Suite 200, 10345 - 105 Street NW, Edmonton, AB T5J 1E8 | T: 780.430.4041

File: 2847.0015.01

This report is prepared for the sole use of Little Red River Group of Companies LP. No representations of any kind are made by Urban Systems Ltd. or its employees to any party with whom Urban Systems Ltd. does not have a contract. © 2020 URBANSYSTEMS®.

# CONTENTS

1.1 PURPOSE AND SCOPE .....	1
1.2 APPLICABLE POLICY .....	1
1.2.1 FEDERAL POLICY .....	1
1.2.2 PROVINCIAL POLICY (GOVERNMENT OF ALBERTA) .....	1
1.2.3 MUNICIPAL POLICY (MACKENZIE COUNTY) .....	2
<b>2.0 EXISTING CONDITIONS.....</b>	<b>3</b>
2.1 CONTEXT.....	3
2.1.1 REGIONAL .....	3
2.1.2 LOCAL.....	3
2.1.3 THE LANDS .....	3
2.1.4 TRANSPORTATION .....	3
2.1.5 PROGRAMMING.....	4
2.1.6 ENVIRONMENTAL CONSIDERATIONS .....	4
2.1.7 WATER AND SANITARY SERVICES .....	4
2.1.8 POWER, GAS AND TELECOMMUNICATIONS .....	4
2.1.9 HISTORICAL AND ARCHAEOLOGICAL OVERVIEW .....	4
2.1.10 FIRE SMART .....	5
<b>3.0 LAND USE CONCEPT.....</b>	<b>5</b>
3.1 LAND USE STRATEGY .....	5
3.1.1 COMMERCIAL .....	5
3.1.2 INDUSTRIAL.....	5
<b>4.0 INFRASTRUCTURE SERVICING.....</b>	<b>6</b>
4.1 TRANSPORTATION .....	6
4.1.1 SITE ACCESS .....	6
4.1.2 INTERNAL ROADWAYS .....	7
4.1.3 WATER SERVICING .....	8
4.1.4 SANITARY SERVICING.....	9
4.1.5 GEOTECHNICAL .....	9
4.1.6 SITE TOPOGRAPHY AND STORM WATER MANAGEMENT .....	9
4.1.7 SOLID WASTE MANAGEMENT .....	10
4.1.8 POWER, GAS AND TELECOMMUNICATIONS .....	10
<b>5.0 PART IV: IMPLEMENTATION.....</b>	<b>11</b>

5.1 IMPLICATIONS FOR OTHER MUNICIPAL PLANS AND BYLAWS .....11  
5.2 MUNICIPAL AND ENVIRONMENTAL RESERVE .....11  
5.3 DEVELOPMENT PHASES.....11

Appendix A – Caribou Mountain Commercial Park ASP – Traffic Impact Assessment

Appendix B – Email Correspondence with MacKenzie County

# **INTRODUCTION**

## **1.1 PURPOSE AND SCOPE**

This Area Structure Plan (ASP) has been prepared for Little Red River Creen Nation (LRRCN) as required by Mackenzie County (County) for multi-parcel development. LRRCN has been working on several background and feasibility studies for the Caribou Mountain Commercial Park including a Conceptual Development Plan, Servicing Strategy, and a supporting Business Feasibility Study.

As shown in **Figure 1: Location Map**, the Caribou Mountain Commercial Park (the Lands) are approximately 160 acres, located northeast of the intersection of Highways 58 and Highway 88.

The Lands are being planned and constructed in several phases and will contain a mixture of commercial and industrial developments.

## **1.2 APPLICABLE POLICY**

### **1.2.1 FEDERAL POLICY**

Where applicable, the Lands are subject to Federal Acts and Regulations. Examples of relevant applicable legislation include the Migratory Bird Convention Act and the Species at Risk Act. As this project is federally funded by Indigenous Services Canada, they will require an environmental Project Description Form to be submitted as part of the project deliverables.

### **1.2.2 PROVINCIAL POLICY (GOVERNMENT OF ALBERTA)**

The Lands are most directly affected by policies administered by Alberta Transportation and Alberta Environment and Parks. Any development within 800m of a provincial highway requires a Roadside Development Application to be submitted to Alberta Transportation for approval. As the Lands border Highway 58 along the length of the southern boundary, this requirement impacts development of the entire quarter section. It is likely that any Roadside Development permit application will also require submission of a Traffic Impact Assessment to ensure safe access and egress from the provincial highway. Alberta Transportation requires that the general minimum setback for all development is 70 metres from the highway centreline or no closer than 40 metres from the highway right-of-way boundary, except where these distances must be increased to allow for highway widening. Placement of any trees, hedges or shrubs within 30 metres from the highway right-of-way boundary, or 60 metres from the centre line of the highway, whichever distance is greater, is typically prohibited without a permit. Alberta Transportation will also dictate how many accesses are allowed from Highway 58 into the Lands. Their access management guidelines for a minor two-lane highway suggest that access to private lands are not permitted within 400m of a public road intersection and that one access per quarter section is most desirable. Alberta Environment and Parks oversees administration of the Water Act, which is triggered for any modification or removal of wetlands found within the Lands. They also oversee the Environmental Protection and Enhancement Act and Regulations which could be triggered if there is desire to install a communal water and sewer system within the Lands. Private sewage systems fall under the Alberta Safety Codes Council, another provincial body.

Last updated by squalle on October 19, 2020 at 2:35 PM  
 Last exported by squalle on October 15, 2020 1:56 PM  
 Last printed by squalle on September 25, 2017 11:46 AM

U:\Projects\_EDM\2847\001\3\01\1D-Design\GIS\Projects\Pro\_Projects\Little Red Caribou Mountain Base Map\Little Red Caribou Mountain Base Map.aprx\Location

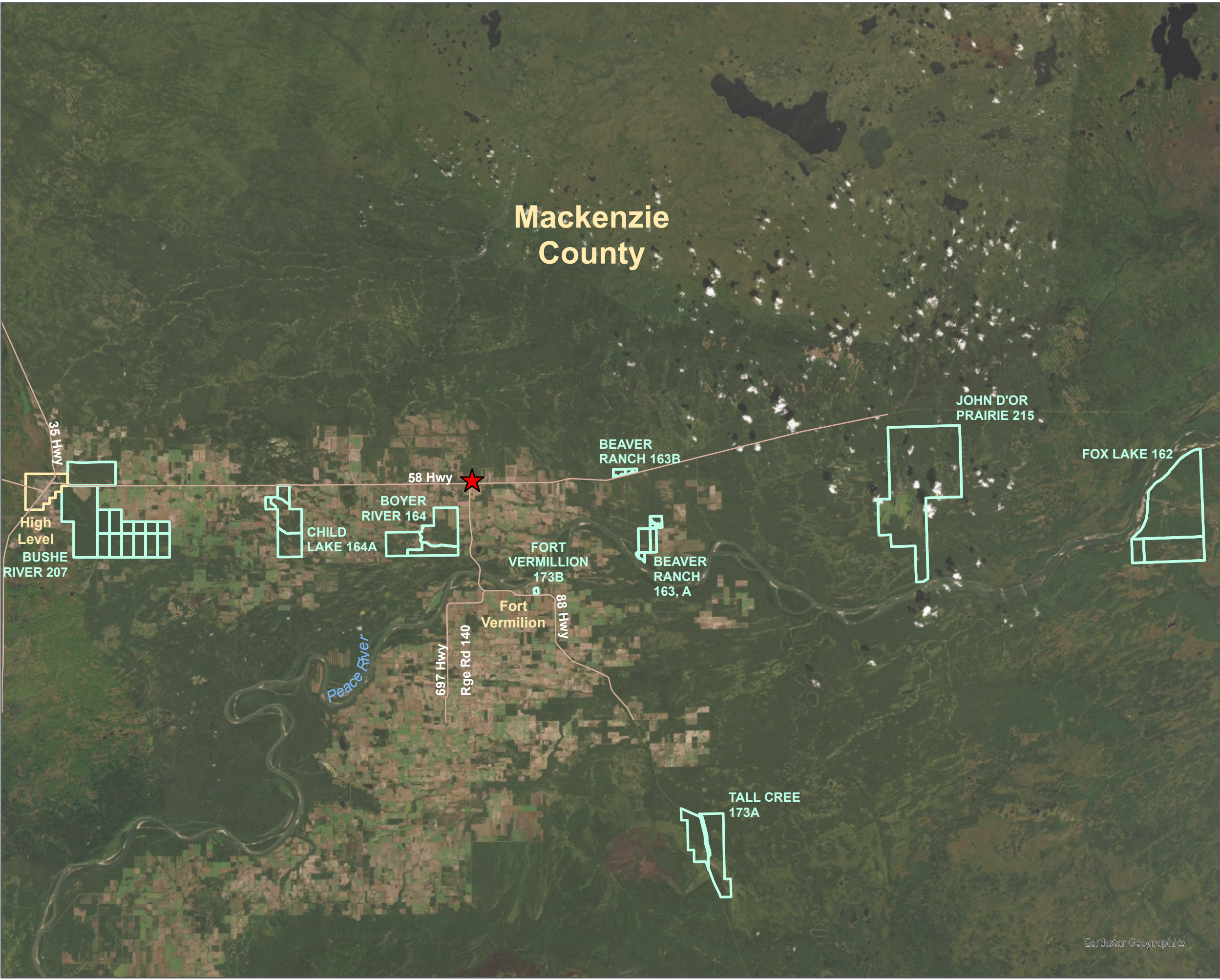

# Mackenzie County



## Caribou Mountain Commercial Park Location Map

- ★ Caribou Mountain Commercial Park
- First Nation Reserve Boundary
- Municipal Boundary

The accuracy & completeness of information shown on this drawing is not guaranteed. It will be the responsibility of the user of the information shown on this drawing to locate & establish the precise location of all existing information whether shown or not.

0 5 10  
 Kilometers

**Coordinate System:**  
 NAD 1983 CSRS UTM Zone 11N

**Data Sources:**

- Canada Lands 2020-09-24
- Abadata 2020-09-28
- National Hydro & Road Network

Project #: 2847.0013.01  
 Author: SQ

Date: 2020 / 10 / 19

**URBAN**  
systems

**FIGURE 1**



### 1.2.3 MUNICIPAL POLICY (MACKENZIE COUNTY)

The Lands are fee simple and subject to the bylaws, policies, and procedures of Mackenzie County where they are located.

#### Municipal Development Plan (MDP)

The Municipal Development Plan (MDP) is the long-range, statutory document that is required to be adopted by Bylaw for all municipalities. The MDP communicates the long-term desired land use for the municipality and serves as a high-level blueprint showing how the municipality is expected to change over time and the shape it will take in the future.

The purpose of the MDP is to provide clear direction for Mackenzie County's Council and Administration. The Plan is intended to guide growth and development of the County to 2031 and to accommodate a population of 17,237. The MDP guides future development by defining the vision, principles, objectives, and policies of the County with respect to planning matters. The MDP, in addition to Provincial legislation, provides a foundation for the preparation of more detailed land use plans; is intended to be used in conjunction with Mackenzie County's Land Use Bylaw to implement its policies; and to inform residents and developers of Mackenzie County's future land use strategy. Any plan for future land use and development must be based on the MDP's vision of the future.

The MDP has designated the Lands at the junction of Highway 88 and 58 as Rural Industrial and Rural Commercial (**Figure 2**). This designation aligns with the proposed uses and general intent LRRCN has for the Lands. The MDP also contains general policies for industrial and commercial development that apply to those land uses throughout Mackenzie County.

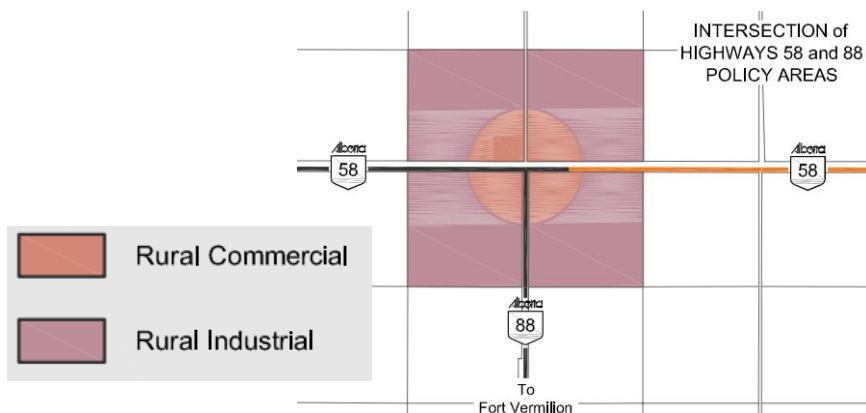

**Figure 2. Mackenzie County MDP Policy Area around Highway 58/88 Intersection**

#### Land Use Bylaw (LUB)

The Land Use Bylaw (LUB) is a statutory plan adopted by Mackenzie County Council as a means to implement the MDP. The LUB divides the municipality into land use districts and establishes procedures for processing and deciding upon development permits and subdivisions. The LUB is the most consulted document by Mackenzie County's administration and the public when starting the development process. The Lands are currently designated as Rural Industrial General (RIG). The LUB states "*The purpose of the RIG district is to provide for heavy industrial uses on large land parcels, distant from residential uses, that utilize extensive outdoor storage areas and on-site operations are considered to be a nuisance to nonindustrial and residential uses.*"

## 2.0 EXISTING CONDITIONS

### 2.1 CONTEXT

#### 2.1.1 REGIONAL

The Lands are located within the jurisdiction of Mackenzie County. Mackenzie County has a population of over 12,000 and is bordered by the Province of British Columbia to the west, the Northwest Territories to the north, Wood Buffalo National Park and the Regional Municipality of Wood Buffalo to the east, and the Municipal District of Northern Lights No. 22, Northern Sunrise County, the Municipal District of Opportunity No. 17 to the south. The Town of High Level, the Town of Rainbow Lake and several First Nations are located within the boundaries of the County but operate independently from the municipality. Mackenzie County's has a diverse economy that includes agri-business, forestry, and oil and gas industries. With primary resources providing the economic base, the development of a strong support service sector has evolved. The diversified economic base provides the County with a balance of industries, and generally protects its economy from severe market fluctuations.

#### 2.1.2 LOCAL

The Lands are located at the junction of Highway 88 and 58. The town of High Level is located a 35-minute drive (58km) west along Highway 58, the Hamlet of Fort Vermillion is 15 minutes south (22km) along Highway 88 and the Nation's administration building is located 1 hour east (69km) along Highway 58 in John D'Or Prairie. The Lands remain mostly undeveloped with significant tree cover on most of the property and potential wetlands along the east and southeast portion. As shown in **Figure 3: Existing Conditions** the Caribou Mountain Travel Centre and CanGas Bulk Propane Storage are the first developments within the Lands and are in the southwest corner. Upgrades are currently underway to the highway intersection and a new public roadway is being added north of the Highway 88 and 58 junction to provide access to the Travel Centre, Propane Storage, and future planned developments.

#### 2.1.3 THE LANDS

The Lands are undeveloped with no known pipelines, oil wells or domestic gaslines that would impede future planning which allows for flexibility with future development. However, much of the land is not visible from Highway 58 or other road rights-of-way, this should be considered during development to ensure visibility of businesses for travellers. The site requires internal roadways to access most future development because of the large distance to the existing roadways.

#### 2.1.4 TRANSPORTATION

The only current access to the Lands is at the junction of Highway 88 and 58, which is a major transportation route in the region. Improvements for the intersection have been planned and are currently being constructed. This includes upgrades from the existing Type IVa, three-legged intersection to a Type IVc, all directional intersection with widened tapers on the east and westbound lanes. Alberta Transportation has plans for a future overlay through this intersection in 2021 which will include lighting upgrades. There is an approximately 40 metre right-of-way north of Highway 58 (parallel) which allows for twinning of the highway in the future. Alberta Transportation has no current plans to twin Highway 58 east of the Highway 88 intersection, however,

Last updated by squalle on October 22, 2020 at 9:31 AM  
 Last exported by squalle on October 19, 2020 2:34 PM  
 Last printed by squalle on September 25, 2017 11:46 AM

U:\Projects\_EDM\2847\001\3\01\1D-Design\GIS\Projects\Pro\_Projects\Little Red Caribou Mountain Base Map\Little Red Caribou Mountain Base Map.aprx\Existing Conditions

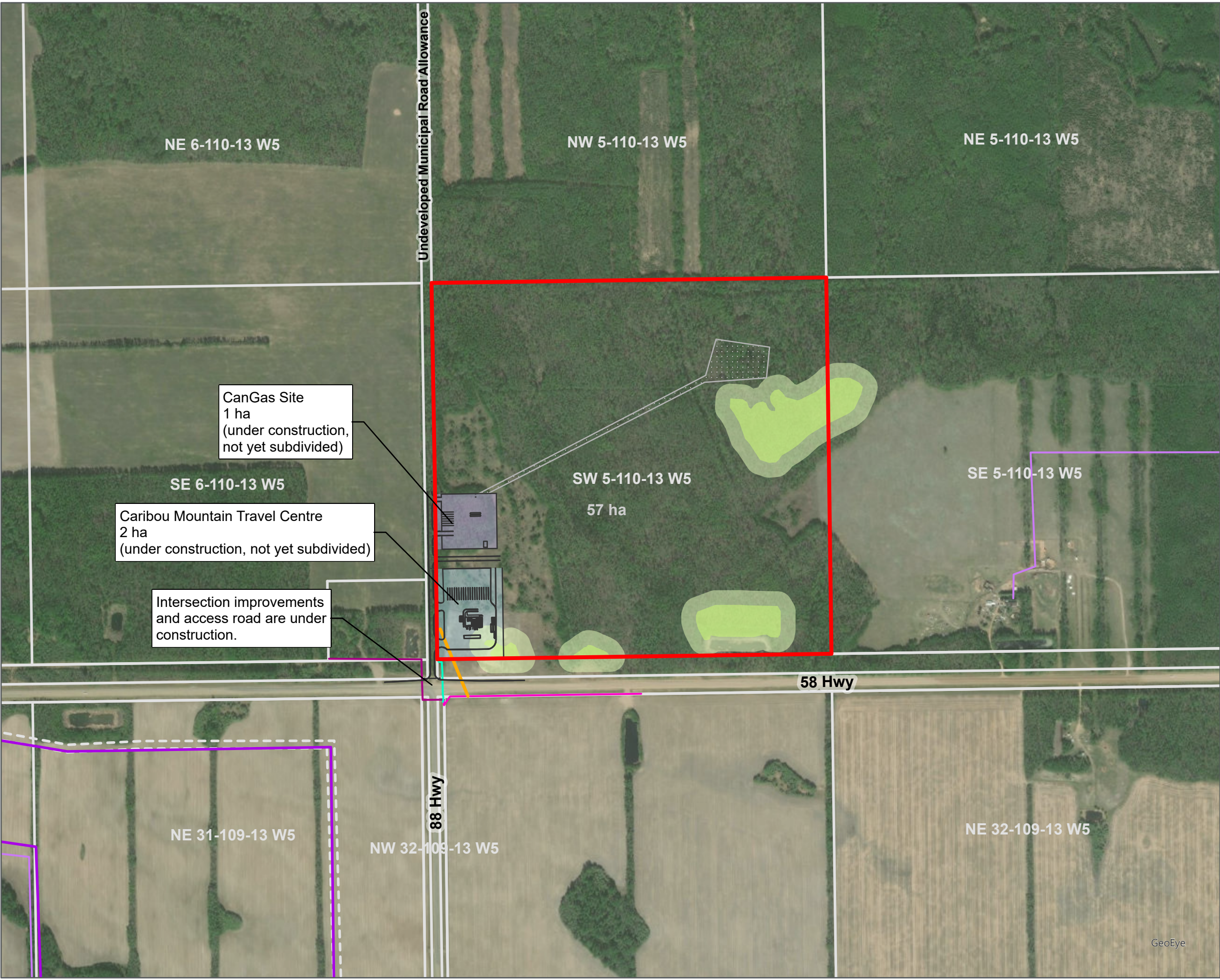

**Caribou Mountain  
Commercial Park  
Existing Conditions**

- Site Boundary
- Oil & Gas Pipe
- Domestic Gas Pipe
- Temporary Road to Borrow Pit
- Overhead 1 Phase Power
- Overhead 3 Phase Power
- Underground 3 Phase Power
- Telecommunications
- Potential Wetlands
- Wetland 30m Offset

The accuracy & completeness of information shown on this drawing is not guaranteed. It will be the responsibility of the user of the information shown on this drawing to locate & establish the precise location of all existing information whether shown or not.



**Coordinate System:**  
NAD 1983 CSRS UTM Zone 11N

**Data Sources:**

- Canada Lands 2020-09-24
- Abadata 2020-09-28
- National Hydro & Road Network
- ESRI Basemap Oct 2020
- Triton Environmental

Project #: 2847.0013.01  
 Author: SQ  
 Date: 2020 / 10 / 22



**FIGURE 3**

GeoEye

this additional 40 metre right-of-way sets development back on the property which affects visibility and exposure for future businesses that rely on passing traffic.

There will be few access points to the property from Highway 58 allowed due to intersection and driveway setback requirements. There are currently no internal roadways on the Lands, which will be required to access most future development.

### 2.1.5 PROGRAMMING

The Lands are designated as Rural Industrial General, which allows for a variety of permitted and discretionary programming. There is also the potential to capture traffic generated by the Caribou Mountain Travel Centre and provide additional services for travellers. Going forward, bylaw amendments may be required if land use deviates from the permitted and discretionary uses in the Mackenzie County Land Use Bylaw.

### 2.1.6 ENVIRONMENTAL CONSIDERATIONS

There are only two potential identified areas of environmental concern within the Lands, two diesel and gasoline above-ground storage tanks being used to support construction of the CanGas and Caribou Mountain Travel Centre. Once the tanks are removed, a limited Phase 2 Environmental Site Assessment is recommended to ensure there were no spills. Wetlands also exist on the property and a wetland assessment may be required by the Crown. The wetlands are mostly concentrated in the eastern and southern sections of the site. A field investigation was conducted in 2020 to clarify the extent of the wetlands, this is reflected in **Figure 3: Existing Conditions**.

The site is mostly tree-covered with some areas cleared or thinned in the southwest portion. However, significant tree clearing will also be required for future development and may trigger additional environmental investigations.

### 2.1.7 WATER AND SANITARY SERVICES

There is currently no piped water on the Lands. There is a proposed waterline within 5km, however the connection to the piped water could take many years to develop with significant capital investment and negotiation with Mackenzie County. Currently, there are no sewer services on the Lands.

### 2.1.8 POWER, GAS AND TELECOMMUNICATIONS

There is existing power, natural gas and communication utilities to the Lands (**Figure 3: Existing Conditions**). Power and fibre optic communications have been run into the southwest corner of the Lands to service the Caribou Mountain Travel Centre.

### 2.1.9 HISTORICAL AND ARCHAEOLOGICAL OVERVIEW

A historical and archeological assessment does not seem to have been completed for the Lands. This study will likely be required for the area structure planning process with Mackenzie County or to support future subdivision. Typically, this process starts with a review of the Province's Listing of Historic Resources by a qualified professional to determine the likelihood of historic resources within the site and if approval under the Historic Resources Act is required prior to development.

## 2.1.10 FIRE SMART

As the plan area develops over time, it's essential to ensure that emergency preparedness and fire prevention is incorporated into site design and development.

The proximity of the site to existing natural areas, as well as densely treed areas along with intensifying wildfire seasons in Northern Alberta emphasize the tangible threat of forest fires to the Lands. The ability of local emergency services to provide effective fire protection is largely dependent on future development patterns, access, and onsite mitigative measures.

FireSmart is a national initiative to reduce the vulnerability of buildings and property to the impacts of fire. Development on the Lands should consider the creation of defensible space by clearing plants and vegetation from within 10m of a structure, considering deciduous species when planting new trees (versus coniferous, which are highly flammable), and ensuring there are no trees or vegetation overhanging the roofs of structures. Detailed FireSmart standards should be consulted for future development.

## 3.0 LAND USE CONCEPT

### 3.1 LAND USE STRATEGY

The Land Use Strategy generally identifies the intended land uses and integrates the natural and man-made considerations of the land (**Figure 4: Land Use Plan**).

#### 3.1.1 COMMERCIAL

Highway commercial is the primary commercial use planned for the Lands. Highway commercial is planned along Highway 88 and will include a variety of commercial businesses targeting the traveling public. The MDP identifies rural commercial for the area's surrounding the Highway 88 & 58 junction, however, there is no Rural Commercial district in the LUB to provide direction on uses. A Highway Commercial district may be proposed in the future for the Lands to align with the purpose of the uses. These land uses could include:

- Grocery Store
- Fast Food Restaurant
- Oil Change / Automotive Repair Centre
- Gas Station Card Lock
- Building Supply Centre

#### 3.1.2 INDUSTRIAL

The primary use on the Lands is planned to be industrial. The Lands are designated as Rural Industrial General in Mackenzie County's Land Use Bylaw and will development in alignment with district's purpose. The purpose of the Rural Industrial General district is to provide for heavy industrial uses on large land parcels, distant from residential uses, that utilize extensive outdoor storage areas.

**OVERALL SITE PLAN**

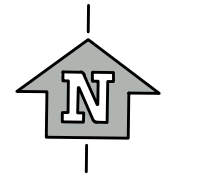

- LEGEND
- PROJECT BOUNDARY
  - PROPOSED LOT LINE
  - WETLAND
  - WETLAND BUFFER
  - PHASE LINE

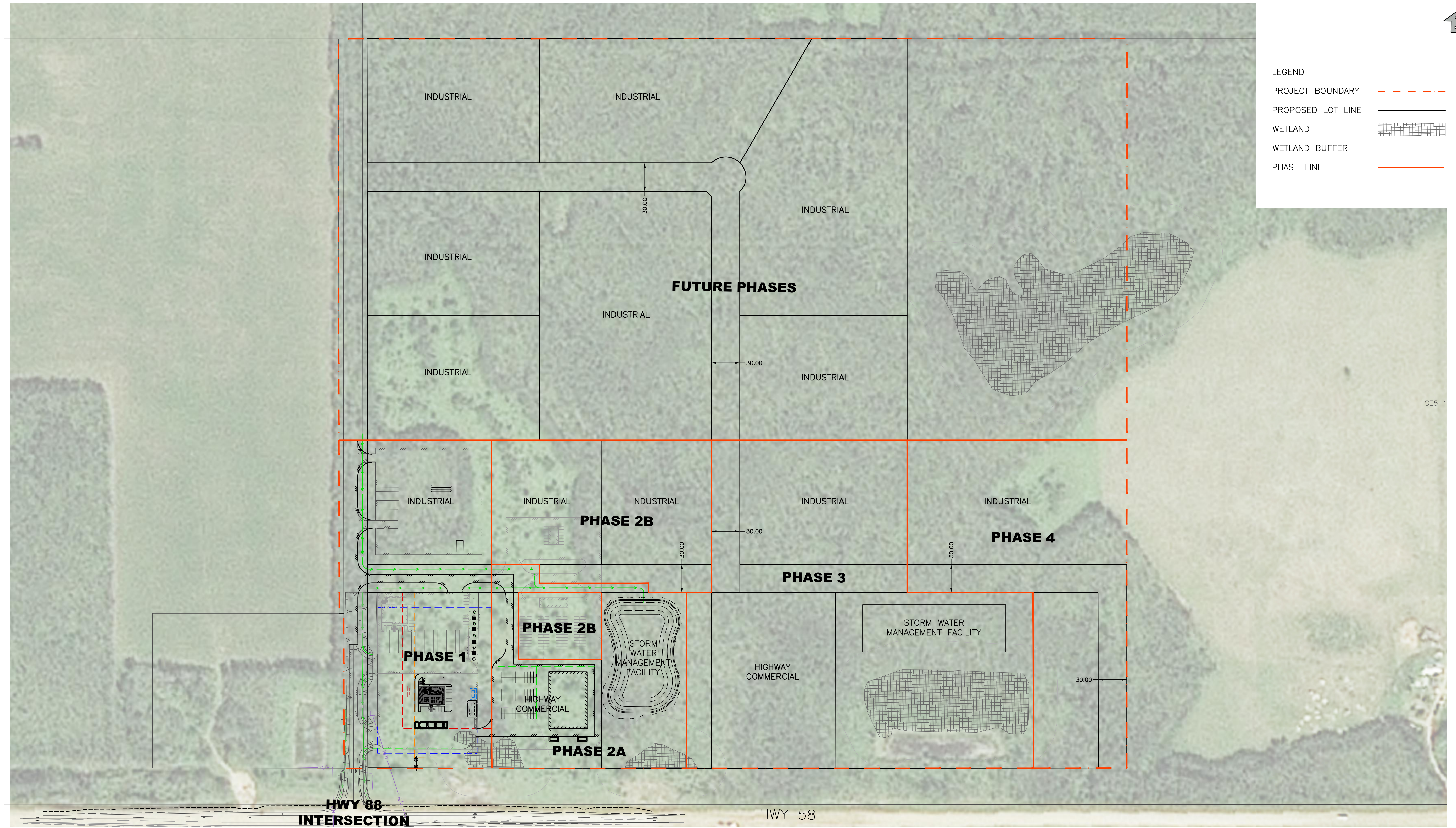

\\usdrmp01\2847\001301\ID-Design\CAD\20\_PROD\FIG\Fig-2847\001301-OVERALL SITE PLAN.dwg, PRELIMINARY, 2021/07/07 10:29 am sathong



ISSUED FOR  
PRELIMINARY  
JULY 7, 2021  
urbansystems.ca

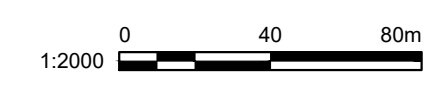

Client/Project	
LITTLE RED RIVER CREE NATION CARIBOU MOUNTAIN COMMERCIAL PARK	
Revision Date	Figure
2021-07-07	01
2847.0013.01	Title

**OVERALL SITE PLAN  
PRELIMINARY**

## 4.0 INFRASTRUCTURE SERVICING

### 4.1 TRANSPORTATION

#### 4.1.1 SITE ACCESS

The only access to the Lands is through the north leg of the Highway 58/88 intersection, which is currently under construction (**Figure 5: Infrastructure Servicing**). Highway 88 does not continue north of the intersection, instead it becomes a public municipal roadway owned and maintained by Mackenzie County. The existing right of way for this municipal roadway is currently 20m wide, however Mackenzie County has initiated a widening process to add 5m on either side for a total of 30m. The first 160m or so of the roadway will only have a 25m right of way as the County was not able to secure the additional 5m to the west from the existing parcel.

The municipal roadway will have a 9m wide paved surface. This is consistent with a Collector Rural Road Standard as identified in Mackenzie County's Rural Road, Access Construction and Surface Water Management Policy PW039 (**Figure 6**). This size of roadway is typically suitable for the type of large vehicle traffic that is expected to frequent the CanGas and Caribou Mountain Travel Centre.

#### Mackenzie County Rural Road Standards/Specifications

	Unit	Collector	Local Road
Road Top Width	m	9m	8m
Avg Height of Fill (min)	m	1.0m	0.9m
Normal Side Slope	run:rise	3:1	3:1
Normal Ditch Width (min)	m	3m	1-3m
Normal Back slope	run:rise	2:1	2:1
Compaction @ Construction	% of Standard Proctor Density	98%	97%
Moisture Content @ Construction	% of Standard Proctor Density	+ / - 1%	+ / - 3%
Rate of Regraveling		Up to 300m <sup>3</sup> /mi	Up to 200m <sup>3</sup> /mi
Private Approach Radius	m	12m	12m
Crown Rate (m/m)		3-4%	3-4%
Right of Way (min)	m	30m	20m

**Figure 6: Rural Road Standards/Specifications**

Last updated by squalle on October 22, 2020 at 11:44 AM  
 Last exported by squalle on October 22, 2020 11:35 AM  
 Last printed by squalle on September 25, 2017 11:46 AM

U:\Projects\_EDM\2847\0013\01\1D-Design\GIS\Projects\Pro\_Projects\Little Red Caribou Mountain Base Map.aprx\Servicing

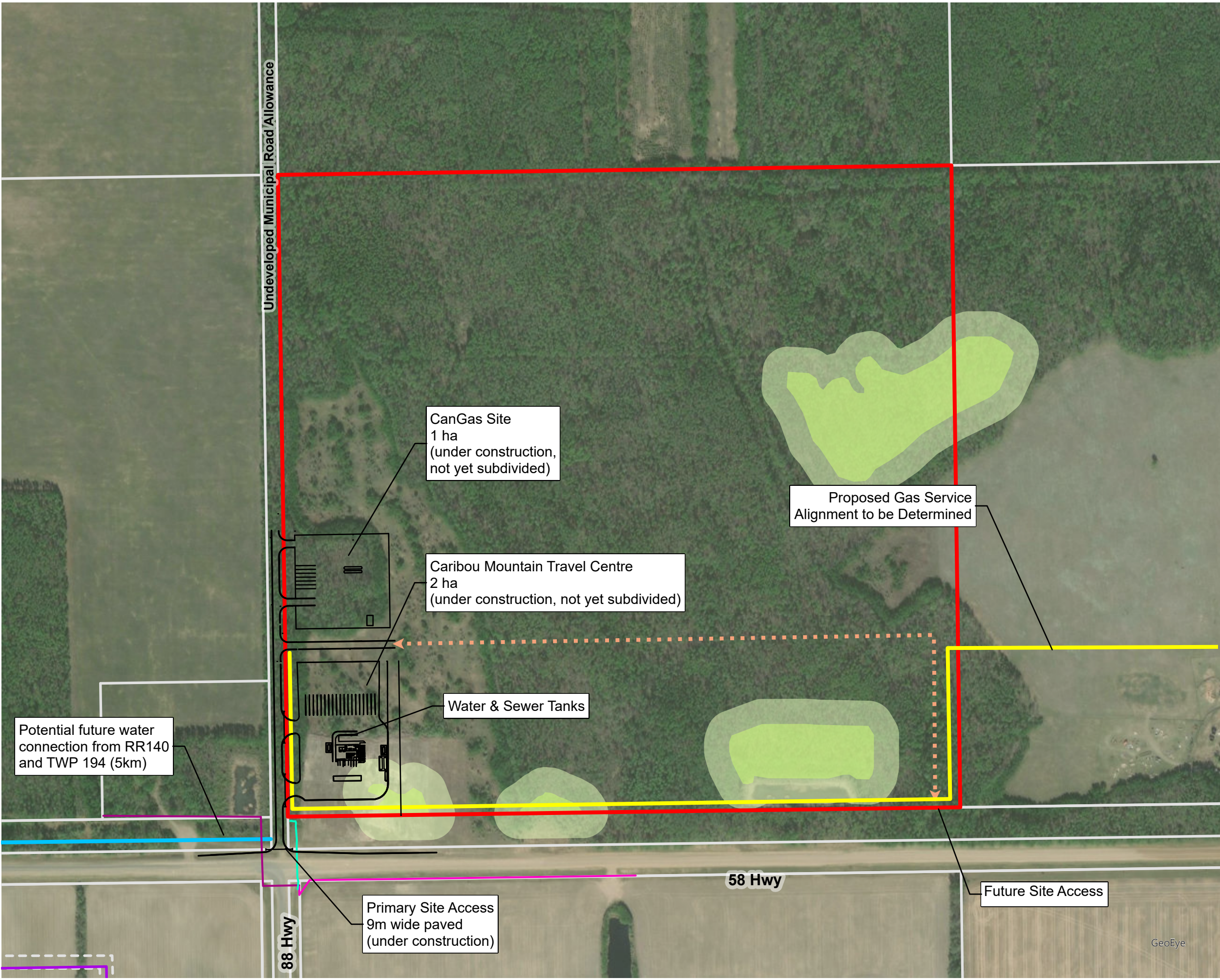

**Caribou Mountain  
 Commercial Park  
 Development Considerations  
 Infrastructure Servicing**

- Site Boundary
- Future Servicing**
- Potential Future Water
- Proposed Gas Service
- Anticipated Continuation of Service Road
- Existing Utilities**
- Telecommunications
- Overhead 1 Phase Power
- Overhead 3 Phase Power
- Oil & Gas Pipe
- Potential Wetlands
- Wetland 30m Offset

The accuracy & completeness of information shown on this drawing is not guaranteed. It will be the responsibility of the user of the information shown on this drawing to locate & establish the precise location of all existing information whether shown or not.



**Coordinate System:**  
 NAD 1983 CSRS UTM Zone 11N

**Data Sources:**

- Canada Lands 2020-09-24
- Abadata 2020-09-28
- National Hydro & Road Network

Project #: 2847.0013.01  
 Author: SQ

Date: 2020 / 10 / 22

**URBAN**  
 systems

**FIGURE 5**

GeoEye



An example of the cross section for this roadway is shown in **Figure 7**.

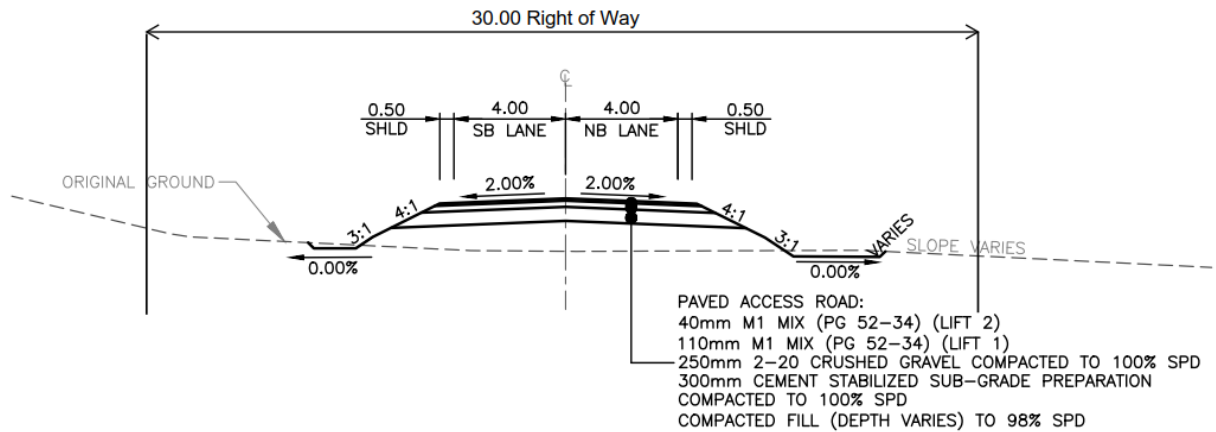

**Figure 7: Access Road North of Highway 58**

All future access points to the Lands are most likely to come from Highway 58 as the nearest municipal roadway is 1.6 km to the west (Range Road 140) and 2.4 km to the north (Township Road 1102). East of Highway 88, Highway 58 is considered a minor two-lane highway. Alberta Transportation's access management guidelines for a minor two-lane highway suggest that access to private lands are not permitted within 400m of a public road intersection and that one access per quarter section is most desirable.

There is an existing farm access to the quarter section south of the Lands located approximately 400m east of the Highway 58/88 intersection off Highway 58. This leaves the potential open for a future site access to the Lands at the same location. Otherwise, the only other access point that Alberta Transportation is likely to accept is 800m east of the Highway 58/88 intersection (at the quarter section line). Approval for either of these future access locations would require submission of a Roadside Development Permit application along with an updated Traffic Impact Assessment. The extent of upgrades to Highway 58 to support either of these access locations would depend on the anticipated traffic volumes generated by future development. Refer to **Figure 4: Land Use Plan** for existing and potential future access locations.

#### 4.1.2 INTERNAL ROADWAYS

There are currently no internal roadways that have been constructed within the Lands. An east/west 9m wide roadway is proposed in between the CanGas and Caribou Mountain Travel Centre that would tie into the north/south municipal roadway that is currently under construction. It is assumed that this proposed roadway will have a 30m right of way and a similar cross section to the north/south roadway.

Service roads are often constructed parallel to major provincial highways to provide safe access and egress to adjacent businesses. A service road was not proposed parallel to Highway 58 along the south boundary of the Lands as it would have pushed the Caribou Mountain Travel Centre (and future developments) too far away from Highway 58, reducing the visibility needed to encourage users into

the site. Instead, a service road is anticipated along the north side of the Travel Centre as shown in **Figure 4: Land Use Plan** and would likely have a cross section similar to that shown in **Figure 7**.

A 30m right of way for internal roadways would allow for ditches on both sides of the road and opportunity for it to be used as a corridor for buried and/or overhead utilities (power, gas, communications, water, sewer, etc.). It is anticipated internal roadways would be owned and maintained by the County once constructed.

### 4.1.3 WATER SERVICING

Proposed buildings on the site including the Caribou Mountain Travel Centre will be serviced by a water cistern system. We understand that the option for a private water well was investigated as part of the servicing design for the travel centre, but discussions with local drillers and landowners (including LRRCN) identified poor groundwater quality in the area. The Class 'D' cost estimate assumes each individual lot will have an individual water system. The installation cost of each system was assumed to be the same, regardless of usage or type of structure on the lot.

A study was completed for Mackenzie County by Associated Engineering in 2015 that investigated the potential for regional potable water pipelines in the vicinity of LaCrete and Fort Vermillion (among other things). **Figure 8** shows the proposed alignment of a proposed potable water trunk main from Fort Vermillion to a proposed Rocky Lane Truckfill Station at Highway 58 and Range Road 145. This proposed alignment comes within approximately 5km of the Lands where it turns west down Township 1094 at Range Road 140. It is currently unknown what the status of this proposed waterline is. If the proposed uses within the Lands would significantly benefit from piped water, it is recommended that discussions are initiated with Mackenzie County to discuss the technical and financial implications of connection to this line.

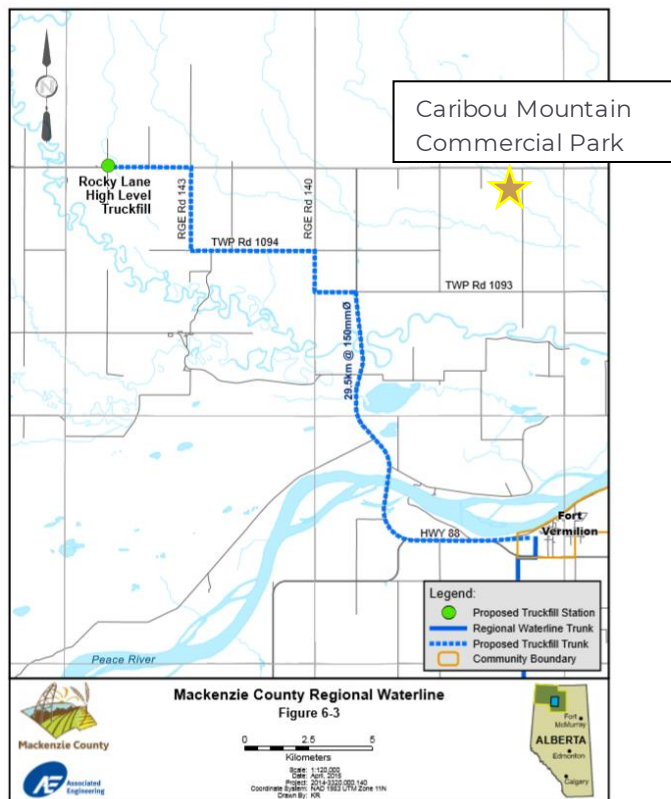

### **Figure 8: Mackenzie County Proposed Waterline (Modified from Associated Engineering, 2015)**

If groundwater quality in the region is generally poor and the opportunity to connect to piped water is low, the only other feasible alternative may be trucked water for all future development on the site. This is typically the least costly and simplest to implement up front, but there can be operational implications and relatively high operations costs associated with trucking water.

Unless piped water is installed to the Lands, it is recommended that any future development is one that is not a large water user.

#### **4.1.4 SANITARY SERVICING**

With no piped sewer connections available nearby, each future development on the Lands will need to consider onsite private sewage treatment (i.e. septic fields, mounds or package treatment plants) or onsite holding tanks. The Alberta Private Sewage Systems Standards of Practice set out design standards, installation standards and material requirements for on-site private sewage systems handling less than 25 cubic metres (5,500 Imperial gallons) of sewage volume per day. The two options for sanitary servicing on the Lands are explained further below:

- Option 1: Each building on the Lands has on-site septic treatment (septic tank).
- Option 2: Gravity mains would be constructed in the short term, with holding tanks being at the location of the lowest elevation (i.e. the storm pond). These holding tanks will be replaced with lift stations once the piped system is installed.

As the desired uses for the Lands are defined, it would be important to determine if a private communal wastewater treatment system is warranted or if separate onsite systems are more practical for each development.

If groundwater quality in the region is generally poor and the opportunity to connect to piped water is low, the only other feasible alternative may be trucked water for all future development on the Lands. This is typically the least costly and simplest to implement up front, but there can be operational implications and relatively high operations costs associated with trucking water.

#### **4.1.5 GEOTECHNICAL**

ENC Testing completed a geotechnical site investigation in 2018 and 2020 to support the Caribou Mountain Travel Centre and access road design and construction. In general, the in-situ material was found to be suitable for construction. There were significant areas of previous fill found within the test areas that will require reworking as part of the site development. Due to the tree cover over the rest of the Lands, it is unlikely that additional fill material will be found. Groundwater elevations found in the test holes indicated levels were approximately 3.5m below the surface.

A site-specific geotechnical site investigation for any future development is recommended as ground conditions can vary drastically in different areas of the site.

#### **4.1.6 SITE TOPOGRAPHY AND STORMWATER MANAGEMENT**

**Figure 9: Stormwater Management** shows the existing ground topography within the site and the immediate surroundings. It also includes consideration for a future stormwater management facility location based on existing low spots in the landscape. The following provides a list of general considerations:

- The Lands are located at the southwest fringe of an unnamed creek's basin. This basin is quite large (about 44 km<sup>2</sup>) and the creek crosses Highway 58 about 4 km east of the site.
- The entire site drains south toward Highway 58, and only the quarter section to the north appears to drain through the site. All other areas around the site appear to drain directly toward the Highway, bypassing the site all together.
- We assume that any kind of stormwater management facilities within the Lands will not need to control offsite runoff from the quarter section to the north, and that only excess runoff from the Lands will need to be controlled. Stormwater management systems would need to be designed to allow pre-development off-site runoff to flow through, under the assumption that any kind of development in the quarter section to the north will include its own stormwater management controls to pre-development rates. Since this quarter section will inevitably flow through the site, consideration may need to be given to a drainage path or right-of-way to allow for this.

Culverts were assumed across all intersections on site (2-3 per intersection), as well as at all accesses into lots (2 accesses/lot). Not including roadways constructed in Phase 1 and 2A, 12 culverts were included for the 4 intersections, including accesses from Highway 58, as well as a further 26 culverts for lot accesses.

In addition to the Phase 2A pond, a stormwater management facility would likely need to be located at the southeast corner of the site, which is the lowest point, to control excess runoff to pre-development rates for the entire quarter section. However, the adequacy of the Highway ditch as an outlet would need to be evaluated in more detail, as it appears to have little topographic relief, and appears to be very shallow compared to the site's ground elevation (which would result in a pond with an excessively large footprint). There are no other obvious outlets.

An alternative to a pond would be to create drainage features throughout the site (i.e., ditches/bioswales), all draining in a southerly direction toward the Highway. These features could be designed to store excess runoff using culverts as controls, and vegetation would serve water quality enhancement purposes.

It is anticipated stormwater management facilities located on utility parcels and within the public road rights-of-way would be maintained by the County once constructed except for occasional mowing which will be the responsibility of the developer. Stormwater management facilities will be designed to have low maintenance requirements with the control structure, outlet, and dry hydrant to be checked and cleaned out as required.

#### **4.1.7 SOLID WASTE MANAGEMENT**

Mackenzie County operates several solid waste transfer stations in the region, including the Fort Vermillion and Rocky Lane's transfer stations. Each development within the Lands will need to consider onsite locations for solid waste management which will include setting up contracts to haul waste to the regional landfill.

#### **4.1.8 POWER, GAS AND TELECOMMUNICATIONS**

There is an existing overhead three phase power line that runs along the entire south boundary of the Highway 58. An underground three phase power service is proposed from this line to a transformer on the west side of the Caribou Mountain Travel Centre site. Service is provided by Atco Electric. Capacity to service future development from this service is unknown.

Last updated by squalle on October 22, 2020 at 11:01 AM  
 Last exported by squalle on October 22, 2020 10:58 AM  
 Last printed by squalle on September 25, 2017 11:46 AM

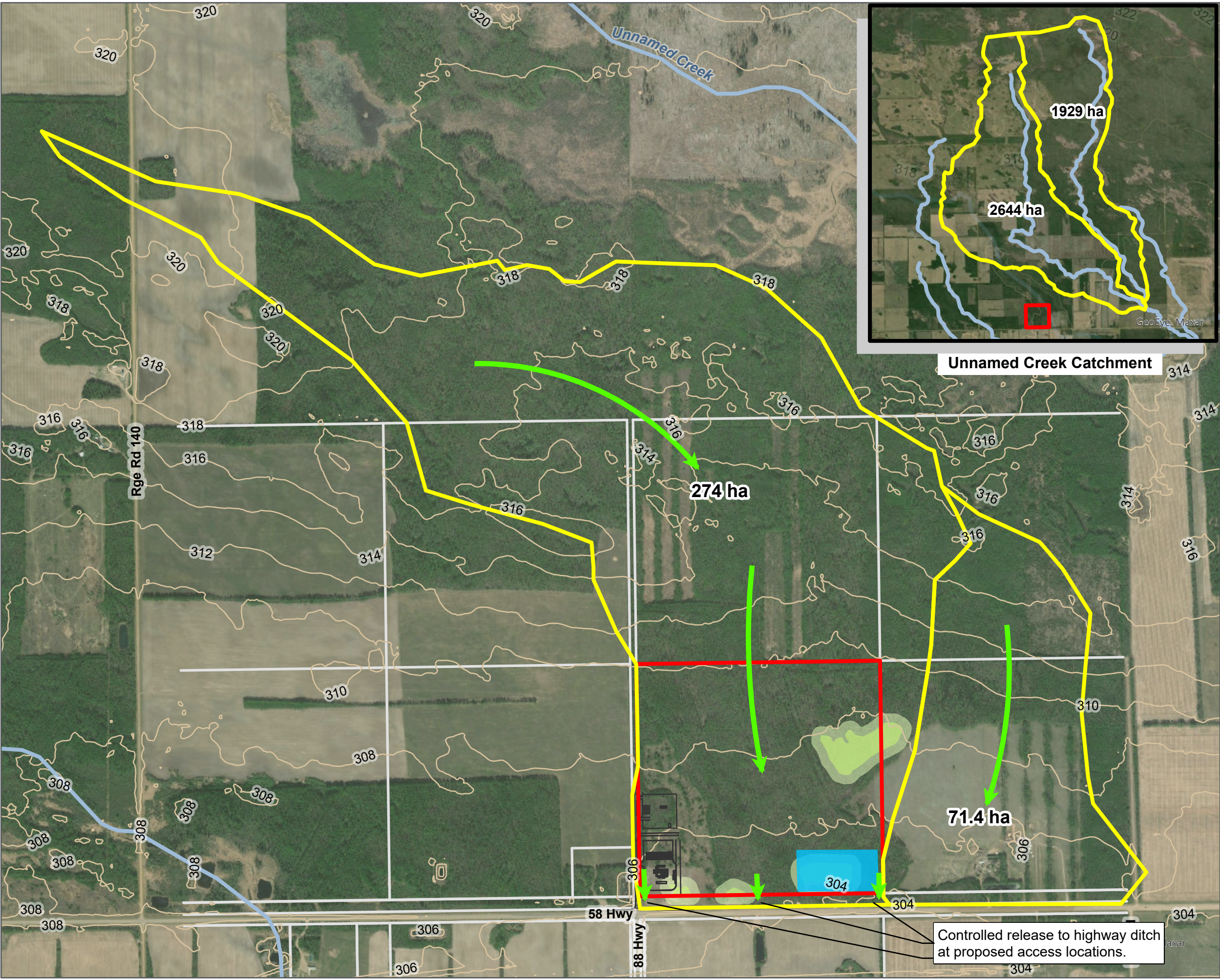

**Caribou Mountain  
 Commercial Park  
 Stormwater Management**

- ▭ Site Boundary
- ▭ Watershed
- ➔ Drainage Direction
- ▭ Potential Stormwater Management Facility
- Contours 2m
- ▭ Potential Wetlands
- ▭ Wetland 30m Offset
- Watercourses
- Caribou Mountain Travel Centre & CanGas Site

The accuracy & completeness of information shown on this drawing is not guaranteed. It will be the responsibility of the user of the information shown on this drawing to locate & establish the precise location of all existing information whether shown or not.

0 100 200  
 Meters

**Coordinate System:**  
 NAD 1983 CSRS UTM Zone 11N

**Data Sources:**

- Canada Lands 2020-09-24
- Abadata 2020-09-28
- National Hydro & Road Network

Project #:	2847.0013.01	<b>URBAN</b> systems
Author:	SQ	
Date:	2020 / 10 / 22	<b>FIGURE 9</b>

U:\Projects\_EDM\2847\0013\01\1D-Design\GIS\Projects\Pro\_Projects\Little Red Caribou Mountain Base Map\Little Red Caribou Mountain Base Map.aprx\Stormwater

We understand fibre communications service was installed to service the Caribou Mountain Travel Centre, but the alignment and capacity to service future development is unknown.

Natural gas service is proposed from the property to the east to the Caribou Mountain Travel Centre. The alignment has yet to be confirmed. Service is provided by the Northern Lights Gas Co-op and they have confirmed that the proposed service to the Travel Centre does not have capacity to support any future development. Offsite upgrades would be required.

It is recommended that all shallow utilities be located within utility or road rights of way to ensure easy access for future development and for maintenance by the utility providers.

## 5.0 **PART IV: IMPLEMENTATION**

Implementation outlines the necessary steps to successfully bring this ASP to life. The following sections address planning processes and the development phase sequencing for the Lands.

### 5.1 **IMPLICATIONS FOR OTHER MUNICIPAL PLANS AND BYLAWS**

The ASP was created to consistently align with the goals and policies outlined in the MDP, LUB and other municipal, provincial, and federal policy. To achieve harmony between this ASP and existing policy documents, the following is required:

- Review and update the LUB to reflect any differences between the Land Use Concept and the current land use district.
- Review this ASP on a periodic basis.

### 5.2 **MUNICIPAL AND ENVIRONMENTAL RESERVE**

Mackenzie County requires that 10% of all subdivision areas be dedicated as Municipal Reserve, in accordance with the provisions of the Municipal Government Act. To create a complete and functional community, cooperation and a strategy is required to ensure that Municipal Reserve is in appropriate locations to serve future residents. In the case where Municipal Reserve land would not effectively serve current and future residents and would be unnecessarily costly for Mackenzie County to maintain and operate, 'cash in lieu' may replace a land reserve in the plan area. These cash-in-lieu funds should be used for new or upgraded recreation facilities in nearby areas of the County.

### 5.3 **DEVELOPMENT PHASES**

The Lands are separated into four specific development phases, with future phases planned more long-term (**Figure 4: Land Use Plan**).

Phase 1 involves the construction of the Caribou Mountain Travel Centre and CanGas Bulk Propane site in the southwestern corner of the Lands. These are scheduled to be finished construction at the end of 2021. Additional phases of development will be pursued as demand warrants.

# Appendix A – Caribou Mountain Commercial Park ASP – Traffic Impact Assessment

**CARIBOU MOUNTAIN**  
**COMMERCIAL PARK ASP –**  
**TRAFFIC IMPACT**  
**ASSESSMENT**

**PREPARED FOR**

Little Red River Cree Nation

This report is prepared for the sole use of Little Red River Cree Nation. No representations of any kind are made by Urban Systems Ltd. or its employees to any party with whom Urban Systems Ltd. does not have a contract. Copyright 2021.

**CONTACT**

Saeed Bashi  
t. 306.880.5214  
sbashi@urbansystems.ca

**OFFICE**

Suite 101 – 134 11 Avenue SE  
Calgary, AB, T2G 0X5  
www.urbansystems.ca



# TABLE OF CONTENTS

<b>1.0 EXECUTIVE SUMMARY.....</b>	<b>5</b>
<b>2.0 INTRODUCTION.....</b>	<b>6</b>
2.1 Background.....	6
2.2 Study Objective & Scope.....	6
2.3 Existing Infrastructure Conditions.....	8
2.4 Future Highway and Municipal Plans.....	8
<b>3.0 BACKGROUND TRAFFIC AND PROJECTION.....</b>	<b>9</b>
3.1 Historic Background Traffic Growth.....	9
3.2 Existing Background Traffic.....	9
3.3 2024, 2034 and 2044 Background Traffic.....	11
<b>4.0 PROPOSED DEVELOPMENT TRAFFIC.....</b>	<b>12</b>
4.1 Total Site Trip Generation.....	12
4.2 Proposed Development Trip Distribution and assignment.....	14
<b>5.0 POST DEVELOPMENT TRAFFIC.....</b>	<b>17</b>
5.1 Post Development Traffic Volumes.....	17
<b>6.0 ANALYSIS METHODOLOGY.....</b>	<b>19</b>
6.1 Intersection Treatment Warrants.....	19
6.1.1 <i>Left Turn Warrant Analysis</i> .....	19
6.1.2 <i>Right Turn Warrant Analysis</i> .....	21
6.1.3 <i>Alberta Transportation Intersection Analysis Summary</i> .....	22
6.2 Site Circulation and Access.....	22
6.3 Capacity Analysis.....	23
6.3.1 <i>Background Traffic - Capacity Analysis – All Horizons</i> .....	24
6.3.2 <i>Post Development Traffic 2024 - Capacity Analysis</i> .....	26
6.3.3 <i>Post Development Traffic 2044 – Sensitivity - Capacity Analysis</i> .....	29
6.3.4 <i>Capacity Analysis Summary</i> .....	30
6.4 Roadway cross section and daily volume.....	30
6.5 Illumination warrant.....	31
6.6 Signalization Warrant.....	31
6.7 Pedestrian Warrant Analysis.....	32
6.8 Existing Sags and Crests.....	32

6.9 Intersection Sight Distance.....32

6.10 Stopping Sight Distance .....32

6.11 Collisions Review .....32

**7.0 RECOMMENDATIONS & CONCLUSIONS ..... 33**

**8.0 AUTHORIZATION & CLOSING ..... 34**

## LIST OF FIGURES

Figure 2-1: Caribou Mountain Commercial Park Location ..... 7

Figure 3-1: Existing Traffic Volume – Highway 58 and Highway 88..... 10

Figure 3-2: Background Traffic at Highway 58 and Highway 88 - Year 2024.....11

Figure 3-3: Background Traffic at Highway 58 and Highway 88 - Year 2034.....11

Figure 3-4: Background Traffic at Highway 58 and Highway 88 - Year 2044.....11

Figure 4-1: Proposed Development Trip Distribution for Phase 2A/2B and Phase 3 ..... 14

Figure 4-2: Proposed Development Trip Distribution for Phase 4 and Future Phases..... 14

Figure 4-3: 2024 Proposed Development Trip Assignment – Phase 2A/2B Only ..... 15

Figure 4-4: 2034 Proposed Development Trip Assignment – Phase 3 Only.....15

Figure 4-5: 2044 Proposed Development Trip Assignment – Phase 4 and Future Phases Only .....16

Figure 5-1: 2024 Post Development Traffic Volumes .....17

Figure 5-2: 2034 Post Development Traffic Volumes .....17

Figure 5-3: 2044 Post Development Traffic Volumes ..... 18

Figure 6-1: Forecasted Daily Traffic Volume at Site Build Out ..... 30

# LIST OF TABLES

Table 3-1: Historic Background Traffic Growth Rate - Highway 58 and Highway 88.....	9
Table 3-2: Existing Phase 1 Trip Generation Rate .....	10
Table 4-1: Proposed Development Trip Generation .....	13
Table 6-1: Left Turn Warrant Analysis Results – Eastbound .....	19
Table 6-2: Left Turn Warrant Analysis Results – Westbound .....	20
Table 6-3: Right Turn Warrant Analysis Results – Eastbound .....	21
Table 6-4: Right Turn Warrant Analysis Results – Westbound.....	21
Table 6-5: Level of Service Definition.....	23
Table 6-6: Volume to Capacity Ratio Definition .....	23
Table 6-7: 2024 Horizon Background Traffic Only.....	24
Table 6-8: 2034 Horizon Background Traffic Only .....	24
Table 6-9: 2044 Horizon Background Traffic Only .....	25
Table 6-10: 2024 Horizon Post Development Traffic .....	26
Table 6-11: 2034 Post Development Traffic .....	27
Table 6-12: 2044 Post Development Traffic.....	28
Table 6-13: 2044 Post Development Traffic Sensitivity Analysis .....	29
Table 6-14: Summary of Illumination Warrant Results .....	31

# LIST OF APPENDICES

- Appendix A – Alberta Transportation Correspondence
- Appendix B – Site Plan
- Appendix C – Left Turn Warrant Analysis Alberta Transportation
- Appendix D – Intersection Design and Treatment
- Appendix E – Synchro Output Files
- Appendix F – McKenzie County Road Cross Section
- Appendix G – Illumination Warrant
- Appendix H – Signalization Warrant Analysis
- Appendix I – Sight Distances Profile

# 1.0 EXECUTIVE SUMMARY

Urban Systems Ltd. (USL) was retained by Little Red River Cree Nation (LRRCN) to complete an Area Structure Plan (ASP) of the quarter section of land located in the northeast corner of the intersection of Highway 58 and Highway 88, also known as Caribou Mountain Commercial Park.

This study analyzed the intersections described in **Section 2.1** over the anticipated construction horizons of 2024, 2034 and 2044. Existing traffic volume was estimated using Alberta Transportation (AT) available traffic counts and the approved Phase 1 development traffic volume as provided in the “Caribou Mountain Travel Center Response to TIA comments”, May 2020 Memorandum and the Institute of Transportation Engineer (ITE) Land-Use Code 110 for General Light Industrial which is the anticipated use of gas storage facility.

An annual growth rate for the Highway 58 and Highway 88 traffic volume is calculated using historical Alberta Transportation traffic counts from the intersection of Highway 58 and Highway 88 (Count Reference Number 39960). The calculated historical annual growth rate shows that the through traffic along Highway 58 and Highway 88 increased linearly by 1.2% and 1.1% per year over the past 19 years, respectively. As a conservative approach and per discussion with AT, the future background through traffic volumes along Highway 58 and Highway 88 are grown by 2% linearly per year to the 2024, 2034 and 2044 horizon years. Traffic turning north at the intersection was not adjusted by the mentioned rate as future growth would be driven developments within the Caribou Mountain Commercial Park.

The study utilizes multiple land-use codes from the ITE Trip Generation Manual to estimate the total future traffic generated by the multiple phases of the site. This study relies on the anticipated land uses at the time of completing this study. Future traffic impact assessment updates that build on this study may be required at each phase of development approval, at which time the proposed land use should be confirmed. The Floor Area Ratio (FAR) is assumed to be 10% on all industrial sites based on similar type of developments in rural areas across Alberta.

Based on the analyses completed, the following are the improvements recommended at intersection of Highway 58 with Highway 88 and East Access.

- Dedicated right turn lanes are warranted at the intersection of Highway 58 and Highway 88. The upgrades should be completed after monitoring of traffic growth at the intersection to determine the proper timing of construction.
- Partial/Delineation lighting is to be installed at the intersection of Highway 58 and Highway 88 at opening day and all analyzed horizons. As delineation lighting is already part of the approved Phase 1 improvements (please refer to memorandum submitted by Urban Systems, May 2020 for details), no additional illumination is required for future phases.
- The proposed East Access would operate at acceptable level of service with Type-IIa treatment.

## 2.0 INTRODUCTION

### 2.1 BACKGROUND

Urban Systems Ltd. (USL) was retained by Little Red River Cree Nation (LRRCN) to complete an Area Structure Plan (ASP) of the quarter section of land located in the northeast corner of the intersection of Highway 58 and Highway 88, also known as Caribou Mountain Commercial Park. The land is legally described as SW $\frac{1}{4}$ -5-110-13-W5M with an estimated area of 64.7 Hectares (160 Acres). One component of the ASP is the completion of a Traffic Impact Assessment to evaluate development impact on the adjacent road network.

A portion of the land, labelled Phase 1 and Gas Storage site, are currently under construction and expected to be completed by the end of 2021. Phase 1 development had a Traffic Impact Assessment (TIA) completed by Bunt and Associates in 2018, followed by a Technical Memorandum response to TIA comments completed by Urban Systems submitted and approved in May 2020. Phase 1 of the development will include a gas station and a convenience store catering to highway traffic.

This TIA focuses on the remaining phases in the ASP area, while building from the original TIA for Phase 1. This study will analyze the following intersections in accordance with discussion with Alberta Transportation (**Appendix A**) and industry best practices, as appropriate.

- Highway 58/Highway 88
- Highway 58/East site access
- Range Road 135/North site access
- Range Road 135/Phase 1 site access (Road B)

The analyses will recommend appropriate intersections geometry based on Alberta Transportation *Highway Geometric Design Guide (AT-HGDC)*. These intersections have been identified as the only intersections directly impacted by the proposed development.

**Figure 2-1** illustrates the regional site location. The development will be situated between Highway 58 to the south, Range Road 135 to the west and undeveloped land to the east and north.

**Appendix B** shows the detailed site layout and phasing plan for the proposed development.

### 2.2 STUDY OBJECTIVE & SCOPE

This study will examine the impacts of the proposed development on the listed intersections in **Section 2.1**. The TIA will ensure the intersections meets the capacity and operational requirements needed by the proposed development and AT. The study is prepared in accordance with Alberta Transportation's TIA Guidelines (February 2021) where the scope includes:

- Review of existing background traffic volumes near the development.
- Develop trip generation, distribution, and assignment of the proposed development traffic based on ITE Trip Generation Manual 10th edition trip generation rates.

- Analyses of the impacts of the background and post development traffic on the adjacent roadway system in three major year horizons as follows, a breakdown of land-uses within each phase are included in **Section 4.0**
  - Phase 2A/2B – To be completed by 2024
  - Phase 3 - 10 years (2034)
  - Remaining Phase 4 and Future Phases - 20 years (2044)
- Provide overview of the potential improvements necessary to the road network near the subject site.

**Figure 2-1: Caribou Mountain Commercial Park Location**



## 2.3 EXISTING INFRASTRUCTURE CONDITIONS

Highway 58 is a Level 2, two-lane undivided provincial highway which runs east-west along the south border of the study parcel.

West of its intersection with Highway 88, Highway 58 is approximately 10 meters wide, paved with a posted speed limit of 100 km/hr. In 2019, the east leg registered a weekday adjusted average annual daily traffic (WAADT) of approximately 1,850 vehicles per day (vpd). Heavy vehicles and recreational vehicles (RVs) accounted for approximately 20% of vehicles along the corridor, with the remaining 80% being personal vehicles.

East of its intersection with Highway 88, Highway 58 is approximately 10 meters wide, paved for approximately 305 meters before transitioning into gravel surface with a posted speed limit of 80 km/hr. In 2019, the east leg registered a WAADT of approximately 270 vpd. Heavy vehicles and recreational vehicles (RVs) accounted for approximately 15% of vehicles along the corridor, with the remaining 85% being personal vehicles.

Highway 88 is a Level 2, approximately 10 meter wide, paved, two-lane undivided provincial highway which runs north-south and ends at the intersection with Highway 58. The posted speed limit is 100 km/hr near the study site. In 2019, the highway registered a weekday adjusted average annual daily traffic (WAADT) of approximately 1,480 vpd. Heavy vehicles and recreational vehicles (RVs) accounted for approximately 25% of vehicles along the corridor, with the remaining 75% being personal vehicles.

Highway 58 and Highway 88 is a four-legged intersection with two-way stop-control on the north and south approaches. The north leg of the intersection was recently constructed as part of the ongoing Phase 1 development. The north leg, Range Road 135, is not an extension of Highway 88, but will be a County road. The intersection geometry is Type-IVb with a dedicated left turn lane and shared through/right turn lane. The north and south approaches are one shared all directional lanes. The subject intersection is located within Control Section 88:18; Traffic Control Section 16 (between KM 27.118 and KM 42.508) and Control Section 58:08; Traffic Control Section 08 (between KM 0.000 and KM 56.649).

## 2.4 FUTURE HIGHWAY AND MUNICIPAL PLANS

The preparation of this ASP would serve as a preliminary plan for the entire development area for Little Red River Cree Nation. No other municipal development plans were identified at the time of completing this study.

## 3.0 BACKGROUND TRAFFIC AND PROJECTION

### 3.1 HISTORIC BACKGROUND TRAFFIC GROWTH

Background traffic is the traffic that is present on the road network without the development of the subject site. Historic traffic growth rate and future traffic volumes forecasting were completed using the information provided in Section A.4.3 of the AT-HGDC<sup>1</sup>.

Based on a review of Alberta Transportation's historical AADT for traffic counts along Highway 58 and Highway 88, as summarized in **Table 3-1**, traffic growth rate on Highway 58 increased by a rate of approximately 1.2% per year over the past 19-years and an average of 2.4% per year over the past 5-years. Comparatively, Highway 88 increased annually by an average of approximately 1.1% over the past 19-years and an average of 6.1% over the past 5-years. Given the historic average annual linear growth rate over the past 19-years and discussion with Alberta Transportation, the study will use a background linear annual growth rate of 2.0% for traffic along Highway 58 and Highway 88. This is considered representative based on AT February 2021 TIA guidelines and past 19-year historic growth rate. The 2% growth rate will be applied linearly to background traffic along both highways to estimate traffic volumes for the 2024, 2034 and 2044 horizons. It is noted that the specified growth rate will be applied only to highway traffic volume along east, west and south legs. Traffic to and from Range Road 135 will not be adjusted as volume growth would be driven by future developments within the site.

**Table 3-1: Historic Background Traffic Growth Rate - Highway 58 and Highway 88**

Traffic Count Location		Average Annual Daily Traffic (AADT) (vpd)			Historic Average Annual Growth Rate	
		2002	2016	2020	Past 5-Year	Past 19-year
Highway 58 and Highway 88 (39960)	West Leg Highway 58	990	1,030	1,280	4.88%	1.26%
	South Leg Highway 88	1,000	920	1,250	6.60%	1.11%
	East Leg Highway 58	230	290	290	0.00%	1.15%
<b>Average Along Highway 58</b>					<b>2.4%</b>	<b>1.2%</b>
<b>Average Along Highway 88</b>					<b>6.6%</b>	<b>1.1%</b>

Note: vpd = vehicles per day

### 3.2 EXISTING BACKGROUND TRAFFIC

The intersection of Highway 58 and Highway 88 is an existing intersection that would be impacted by the future traffic volume added. As no traffic counts have been completed since the construction of the north leg the existing traffic volume is estimated based on the approved land use included in the Caribou Mountain Travel Center – May 2020 Memorandum and ITE Land-Use Code 110 for General Light Industrial which is the anticipated use of gas storage facility. **Table 3-2** summarizes the volumes.

<sup>1</sup> Chapter A – Alberta Transportation Highway Geometric Design Guide – April 2018



**Table 3-2: Existing Phase 1 Trip Generation Rate**

ITE Use (Code)	Trip Rate <sup>1</sup>	Units	In %	Out %	Quantity	Total Trips	Inbound Trips (vph) [vpd]	Outbound Trips (vph) [vpd]
Highway Commercial (Gas station and convenience store)	2.56 (4.21) [N/A]	Trips / KSF	50% (50%) [50%]	50% (50%) [50%]	5.4	14 (22) [320]	7 (11) [160]	7 (11) [160]
General Light Industrial (ITE-110)	0.7 (0.63) [4.96]	Trips / KSF	88% (13%) [50%]	12% (87%) [50%]	19.913	14 (13) [99]	12 (2) [49]	2 (11) [49]
<b>Total Phase 1 Trips</b>						28 (35) [419]	19 (13) [209]	9 (22) [209]

<sup>1</sup> As provided by the client group in the original TIA (Bunt, 2018) and TIA Update Memo (Urban Systems, 2020)

<sup>2</sup> Note: AM (PM) [Daily], vph = vehicles per hour; vpd = vehicles per day, KSF = thousand square feet, Trips per KSF or per fueling station

**Figure 3-1** shows the anticipated opening day traffic volumes based on AT 2020 traffic data plus the future traffic volume from Phase 1 development. The AM and PM Peak represent vehicles per hour, and the Daily Trips represent vehicles per day.

**Figure 3-1: Existing Traffic Volume - Highway 58 and Highway 88**

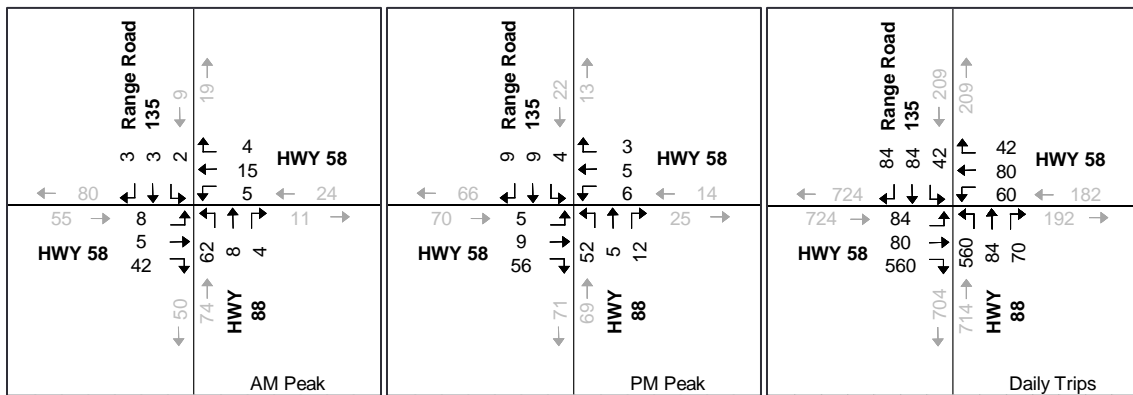

Note: Traffic volumes in black are for turning movements and grey are for directional volumes along the corridor.

### 3.3 2024, 2034 AND 2044 BACKGROUND TRAFFIC

**Figure 3-2, Figure 3-3** and **Figure 3-4** illustrate the background traffic volumes during the AM and PM peak hours, and the daily traffic volumes for the 2024, 2034 and 2044 horizons for the intersection of Highway 58 and Highway 88. As per **Section 3.1**, traffic volumes on all legs, except north leg, of the intersection were adjusted linearly at 2% from 2020 to 2024, 2034 and 2044 horizons.

**Figure 3-2: Background Traffic at Highway 58 and Highway 88 - Year 2024**

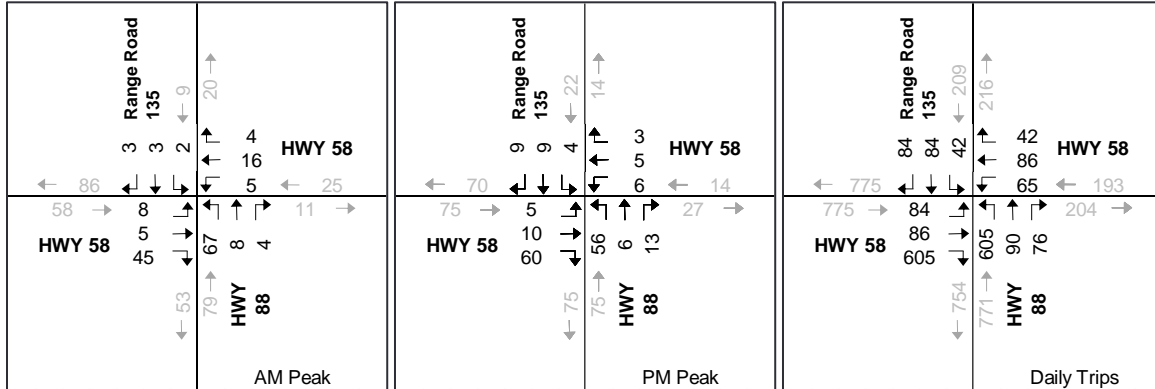

**Figure 3-3: Background Traffic at Highway 58 and Highway 88 - Year 2034**

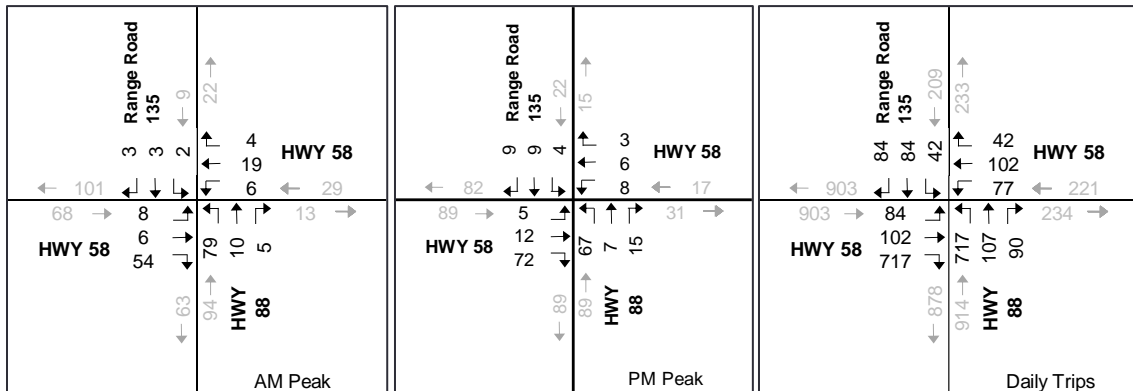

**Figure 3-4: Background Traffic at Highway 58 and Highway 88 - Year 2044**

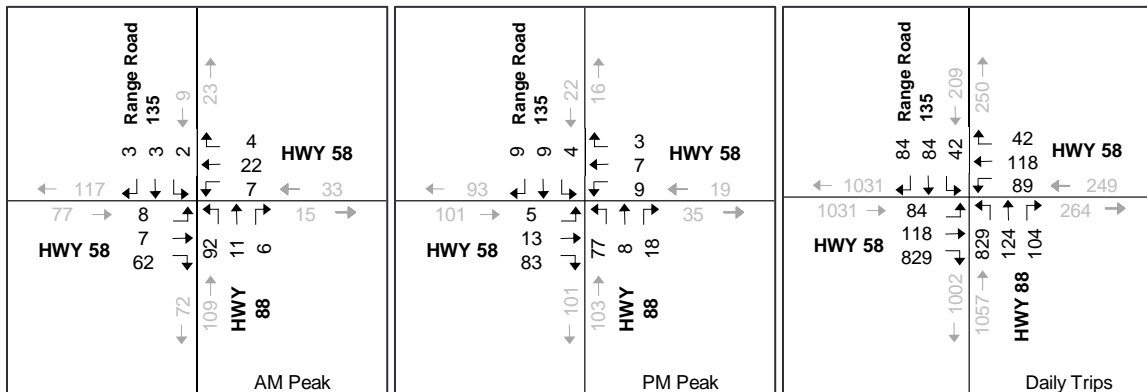

Note (for figures above): Traffic volumes in black are for turning movements and grey are for directional volumes along the corridor.

## 4.0 PROPOSED DEVELOPMENT TRAFFIC

### 4.1 TOTAL SITE TRIP GENERATION

Trip generation rates have been determined for the proposed site in accordance with the recommendations of the Institute of Transportation Engineers (ITE) *Trip Generation Manual (10<sup>th</sup> Edition)*. ITE trip rates represent land-use specific averages that have been developed through years of case studies and background research. Directionality is also indicated in the ITE *Trip Generation Manual* by specifying what percentage of generated trips is heading into the development (inbound trips) versus how many trips are leaving the development (outbound trips) as well the average daily trips anticipated (daily trips).

The study utilizes multiple land-use codes from the ITE Trip Generation Manual to estimate the total future traffic generated by the multiple phases of the site. This study relies on the anticipated land uses at the time of completing this study. Future traffic impact assessment updates may be required at each phase of development approval, at which time the proposed land use should be confirmed. The Floor Area Ratio (FAR) is assumed to be 10% on all industrial sites based on similar developments in rural areas across Alberta. **Table 4-1** summarizes the AM and PM Peak Hours as well the Daily Traffic Volumes for the proposed development site.

The overall site phasing plan is provided in **Appendix B**.

**Table 4-1: Proposed Development Trip Generation**

Land Use Type	ITE Use (Code)	Trip Rate	Unit	In %	Out %	Quantity	Development Trips (vph) [vpd]		
							Total Trips	Inbound Trips	Outbound Trips
<b>Phase 2A + Phase 2B</b>									
Grocery store (i.e., No Frills)	Supermarket (ITE 850)	3.82 (9.24) [106.78]	Trips / KSF	60% (51%) [50%]	40% (49%) [50%]	26.9 KSF	103 (249) [2,872]	62 (149) [1,436]	41 (99) [1,436]
Fast food drive-through (i.e., McDonald's)	Fast food restaurant with drive-through (ITE 934)	40.19 (32.67) [470.95]	Trips / KSF	51% (52%) [50%]	49% (48%) [50%]	4.75 KSF	191 (155) [2,237]	97 (81) [1,119]	94 (74) [1,119]
Oil change (i.e., Jiffy Lube)	Quick lubrication vehicle shop (ITE 941)	5.80 (8.70) [69.57]	Trips / KSF	75% (42%) [50%]	25% (58%) [50%]	1.94 KSF	11 (17) [135]	8 (7) [67]	3 (10) [67]
Gas station card lock (i.e., Petro Pass)	Gasoline / Service Station (ITE 944 See Specialized Use)	1.33 (0.78) [14.94]	Trips/ Pump Station	54% (49%) [50%]	46% (51%) [50%]	8 pumps	11 (6) [120]	6 (3) [60]	5 (3) [60]
<b>Phase 3</b>									
Light use industrial (i.e., laydown yards)	General Light Industrial (ITE 110)	0.70 (0.63) [4.96]	Trips / KSF	88% (13%) [50%]	12% (87%) [50%]	25 KSF	17 (16) [122]	15 (2) [61]	2 (14) [61]
Building Supply Centre	Building Materials and Lumber (ITE 812)	1.51 (2.06) [18.05]	Trips / KSF	63% (57%) [50%]	37% (53%) [50%]	19 KSF	29 (39) [343]	18 (18) [171]	11 (21) [171]
<b>All Remaining Phases</b>									
Phase 4 Light Industrial	General Light Industrial (ITE 110)	0.70 (0.63) [4.96]	Trips / KSF	88% (13%) [50%]	12% (87%) [50%]	32 KSF	23 (20) [161]	20 (3) [80]	3 (18) [80]
Future Phases Light Industrial	General Light Industrial (ITE 110)	0.70 (0.63) [4.96]	Trips / KSF	88% (13%) [50%]	12% (87%) [50%]	236 KSF	165 (149) [1,331]	145 (19) [585]	20 (129) [585]
<b>Total Trips</b>							<b>550 (651) [7,160]</b>	<b>372 (260) [3,580]</b>	<b>178 (391) [3,580]</b>

Note: AM (PM) [Daily], vph = vehicles per hour; vpd = vehicles per day, KSF = thousand square feet, Trips per KSF

## 4.2 PROPOSED DEVELOPMENT TRIP DISTRIBUTION AND ASSIGNMENT

The site will be developed over multiple phases along which accesses would be constructed, as necessary. For the Phase 2A/2B and Phase 3, the site will be accessed through Range Road 135 from the existing intersection of Highway 58 and Highway 88 to reach Phase 1 Access (Road B), which is the same access for Phase 1. By Phase 4 and Future Phases, the site is assumed to have an additional access along Highway 58 and an access along the extended Range Road 135.

Traffic patterns following the development of Phase 4 and North Phases might change slightly. It is assumed that 20% of the Phase 4 and North Phases would utilize the East Access on Highway 58, with the remaining 80% utilizing the intersection of Highway 58 and Highway 88. This is considered reasonable as traffic destined to the industrial land would likely arrive through Highway 58 and Highway 88. Phase 2A/2B and Phase 3 would continue to utilize Highway 58 and Highway 88 intersection along with Range Road 135 and Phase 1 Access (Road B) intersection.

**Figure 4-1** and **Figure 4-2** summarize the distribution split from each phase at the different accesses.

**Figure 4-1: Proposed Development Trip Distribution for Phase 2A/2B and Phase 3**

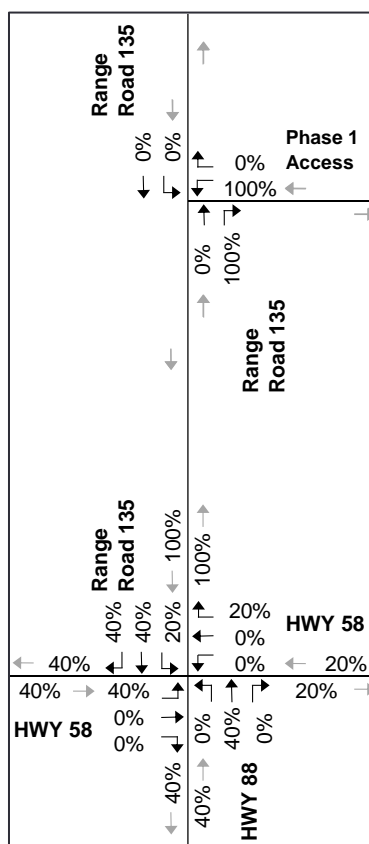

**Figure 4-2: Proposed Development Trip Distribution for Phase 4 and Future Phases**

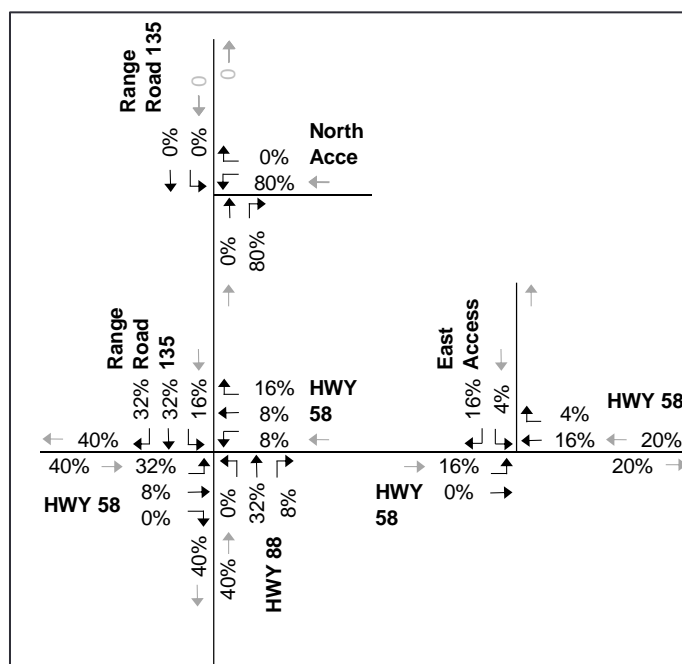

Based on the trip distribution above, the trip assignment for AM and PM peak hour and daily traffic volume at the subject intersection was calculated and summarized in **Figure 4-3**, **Figure 4-4** and **Figure 4-5** for each development phase.

**Figure 4-3: 2024 Proposed Development Trip Assignment – Phase 2A/2B Only**

<p>Range Road 135</p> <p>0 ← 0 ← 0</p> <p>Phase 1 Access</p> <p>0</p> <p>142 ← 142</p>		<p>Range Road 135</p> <p>0 ← 0 ← 0</p> <p>Phase 1 Access</p> <p>0</p> <p>209 ← 209</p>		<p>Range Road 135</p> <p>0 ← 0 ← 0</p> <p>Phase 1 Access</p> <p>0</p> <p>2682 ← 2682</p>	
<p>57 ← 57 ← 28 ← 142</p> <p>Range Road 135</p> <p>173 →</p>		<p>84 ← 84 ← 42 ← 210</p> <p>Range Road 135</p> <p>218 →</p>		<p>1073 ← 1073 ← 536 ← 2682</p> <p>Range Road 135</p> <p>2682 →</p>	
<p>HWY 58</p> <p>69 → 69</p> <p>0 0</p> <p>0 ← 57</p> <p>HWY 88</p> <p>69 → 0</p> <p>0</p> <p>28 →</p>		<p>HWY 58</p> <p>87 → 87</p> <p>0 0</p> <p>0 ← 84</p> <p>HWY 88</p> <p>87 → 0</p> <p>0</p> <p>42 →</p>		<p>HWY 58</p> <p>1073 → 1073</p> <p>0 0</p> <p>0 ← 1073</p> <p>HWY 88</p> <p>1073 → 0</p> <p>0</p> <p>536 →</p>	
<p>AM Peak</p>		<p>PM Peak</p>		<p>Daily Trips</p>	

**Figure 4-4: 2034 Proposed Development Trip Assignment – Phase 3 Only**

<p>Range Road 135</p> <p>0 ← 0 ← 0</p> <p>Phase 1 Access</p> <p>0</p> <p>13 ← 13</p>		<p>Range Road 135</p> <p>0 ← 0 ← 0</p> <p>Phase 1 Access</p> <p>0</p> <p>34 ← 34</p>		<p>Range Road 135</p> <p>0 ← 0 ← 0</p> <p>Phase 1 Access</p> <p>0</p> <p>233 ← 233</p>	
<p>5 ← 5 ← 3 ← 13</p> <p>Range Road 135</p> <p>33 →</p>		<p>14 ← 14 ← 7 ← 35</p> <p>Range Road 135</p> <p>20 →</p>		<p>93 ← 93 ← 47 ← 233</p> <p>Range Road 135</p> <p>233 →</p>	
<p>HWY 58</p> <p>13 → 13</p> <p>0 0</p> <p>0 ← 5</p> <p>HWY 88</p> <p>13 → 0</p> <p>0</p> <p>3 →</p>		<p>HWY 58</p> <p>8 → 8</p> <p>0 0</p> <p>0 ← 14</p> <p>HWY 88</p> <p>8 → 0</p> <p>0</p> <p>7 →</p>		<p>HWY 58</p> <p>93 → 93</p> <p>0 0</p> <p>0 ← 93</p> <p>HWY 88</p> <p>93 → 0</p> <p>0</p> <p>47 →</p>	
<p>AM Peak</p>		<p>PM Peak</p>		<p>Daily Trips</p>	

Note (for figures above): Traffic volumes in black are for turning movements and grey are for directional volumes along the corridor.



# 5.0 POST DEVELOPMENT TRAFFIC

## 5.1 POST DEVELOPMENT TRAFFIC VOLUMES

The Post Development traffic is defined as the projected background traffic, plus other known development traffic and the site generated traffic all summed for the peak periods. Future background traffic volumes have been forecasted for the planned 2024, 2034 and 2044 horizons. The Post Development traffic volumes, which include background traffic and site generated traffic volumes for all three analysis horizons, are shown in **Figure 5-1**, **Figure 5-2** and **Figure 5-3**.

**Figure 5-1: 2024 Post Development Traffic Volumes**

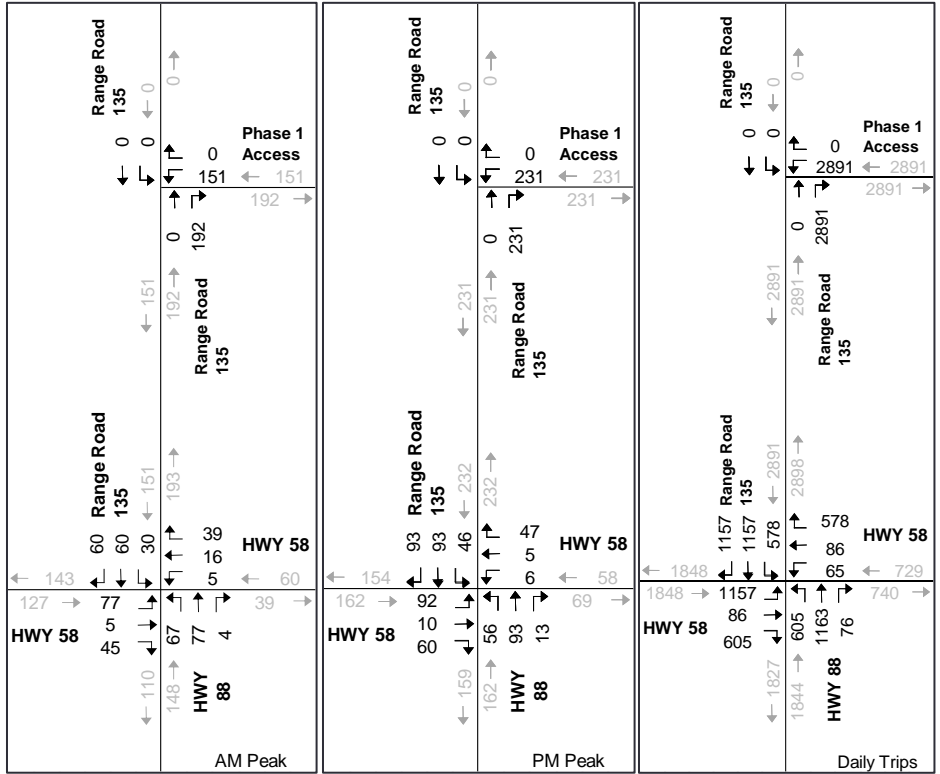

**Figure 5-2: 2034 Post Development Traffic Volumes**

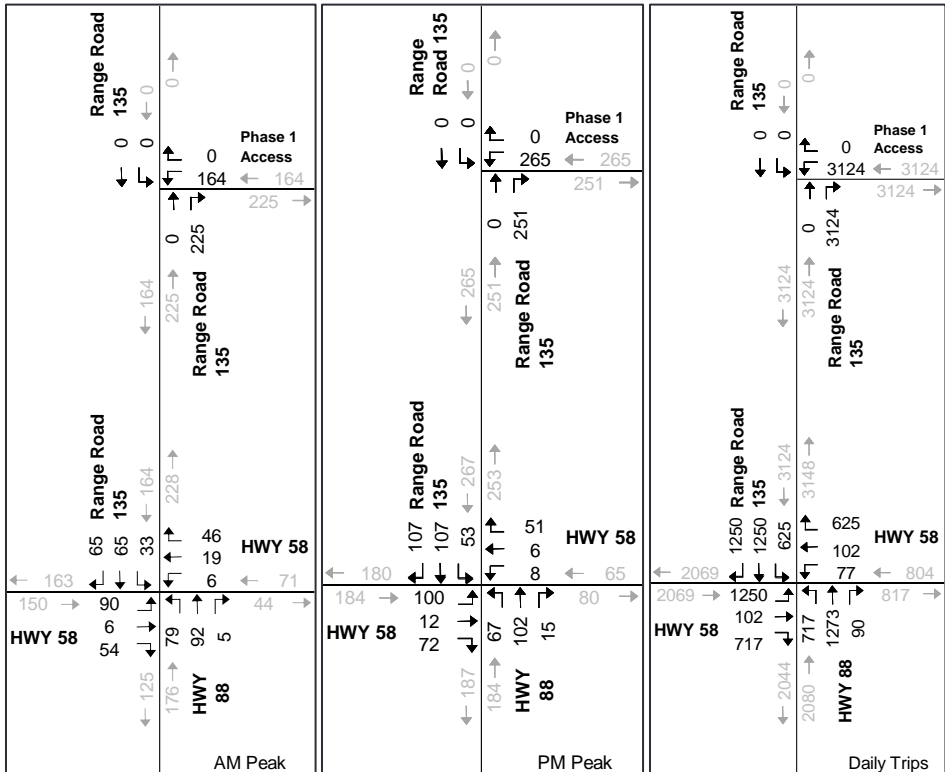

Note (for figures above): Traffic volumes in black are for turning movements and grey are for directional volumes along the corridor.



Figure 5-3: 2044 Post Development Traffic Volumes

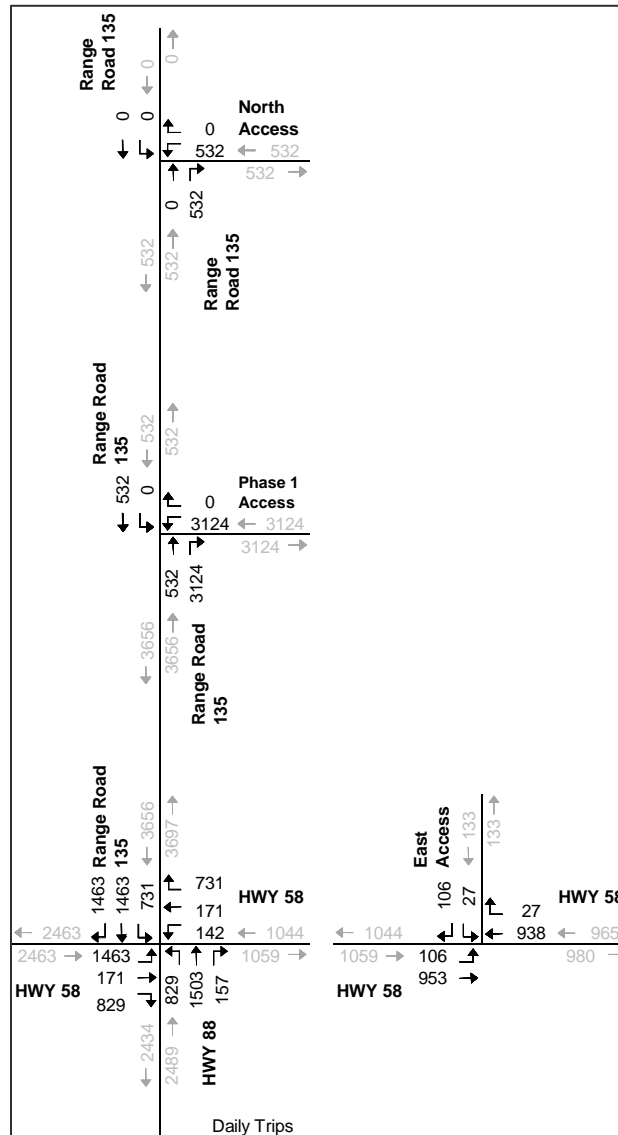
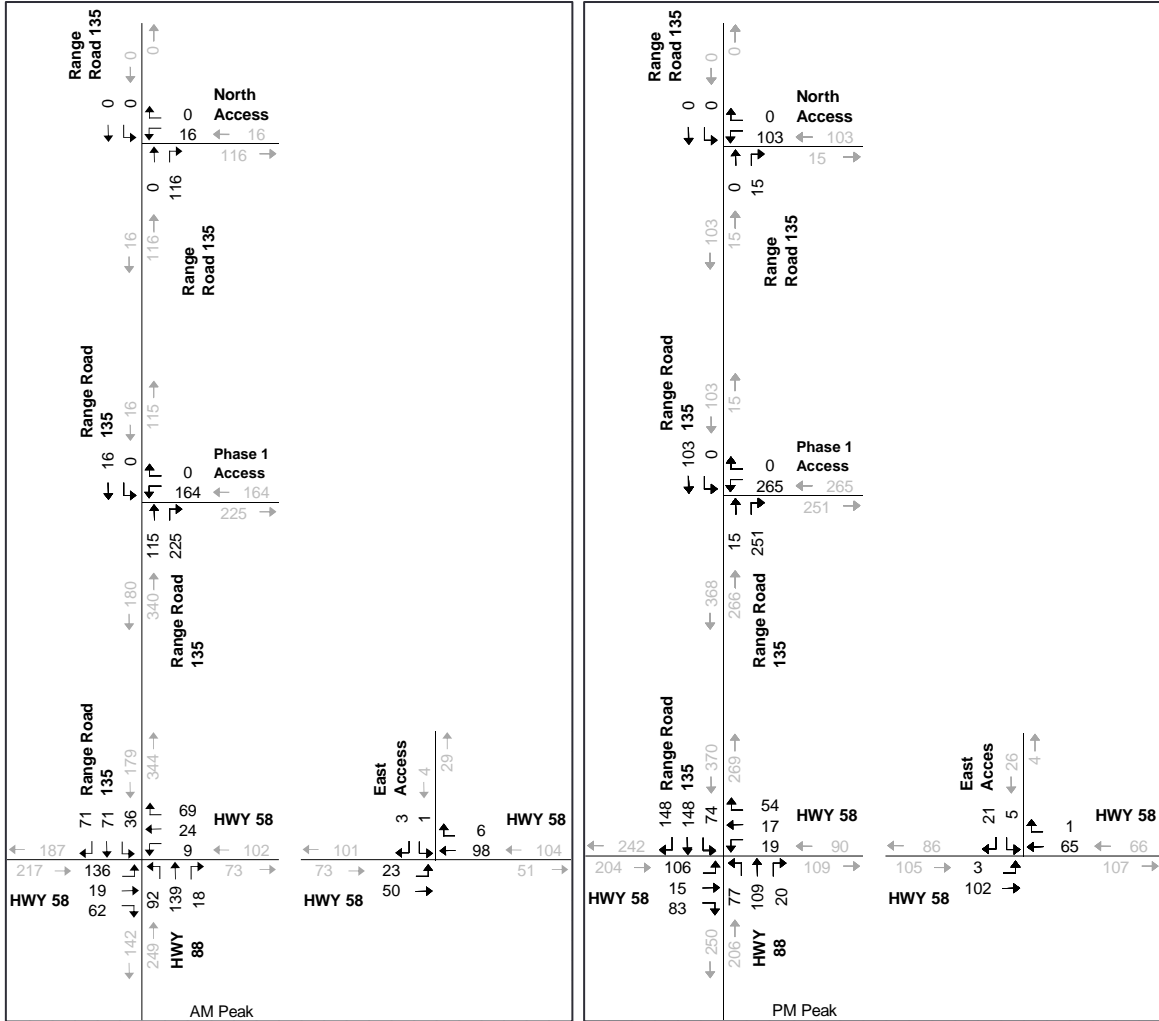

Note (for figures above): Traffic volumes in black are for turning movements and grey are for directional volumes along the corridor.

## 6.0 ANALYSIS METHODOLOGY

Several analyses have been completed based on Alberta Transportation's (AT) Traffic Impact Assessment Guidelines, including AT intersection analysis, collision review, minimum intersection sight distance and stopping sight distance and intersection illumination analysis.

### 6.1 INTERSECTION TREATMENT WARRANTS

Alberta Transportation's Highway Geometric Design Guide (AT-HGDG) is typically used to determine the standard intersection configuration required at the intersection. The AT Intersection layout analysis is designed to determine necessary intersection geometry for rural highways. The analysis results are used to determine the standard intersection treatment necessary as per AT-HGDG. As per the methodology outlined in AT's Highway Geometric Design Guide, warrants for a dedicated left and right turn bays were completed for the intersections along Highway 58 at Highway 88 and at the East Access. It is noted the intersection of Highway 58 and Highway 88 is a Type-IVa intersection. The analysis was not completed for the intersections along Range Road 135. Instead, it is analyzed using the Highway Capacity Manual (HCM) method explained in **Section 6.3**. A summary of intersection treatment analyses results is shown in **Section 6.1.3**

#### 6.1.1 Left Turn Warrant Analysis

The warrant analysis was completed assuming operating speed of 100 km/hr at Highway 58 and Highway 88 intersection and 80 km/hr at the future Highway 58 and East Access. This is based on the currently posted speed near both intersections. Heavy vehicle is expected at 35% of overall site traffic based on existing split and future use of the site.

The intersection of Highway 58 and the East Access was analyzed at the 2044 horizon only as it is not anticipated to be constructed before then.

A summary of AT left turn warrant results, completed using AT intersection treatment warrant sheet, is shown in **Table 6-1** and **Table 6-2**. Detailed analysis sheets are included in **Appendix C**.

**Table 6-1: Left Turn Warrant Analysis Results – Eastbound**

Highway 58 and Highway 88						
Horizon	Time Frame	Left Turn Volume (vehicles)	Volume Advancing (vehicles)	Volume Opposing (vehicles)	Analysis Intersection Treatment	Additional Left Turn Storage Required <sup>2</sup>
2024 Post Development Traffic	AM Peak	73	123	57	Type-II	Not Required
	PM Peak	92	162	57	Type-III	Not Required
2034 Post Development Traffic	AM Peak	86	146	68	Type-III	Not Required
	PM Peak	100	184	64	Type-III	Not Required
2044 Post Development Traffic	AM Peak	132	213	95	Type-IV	Not Required
	PM Peak	106	204	69	Type-III	Not Required
Highway 58 and East Access						
Horizon	Time Frame	Left Turn Volume (vehicles)	Volume Advancing (vehicles)	Volume Opposing (vehicles)	Analysis Intersection Treatment	Additional Left Turn Storage Required
2044 Post Development Traffic	AM Peak	23	72	101	Type-II	Not Required
	PM Peak	3	103	66	Type-II	Not Required

<sup>2</sup> Alberta Transportation intersection analysis two-lane undivided highways (March 8, 2021) <https://open.alberta.ca/publications/traffic-impact-assessment-guidelines>, Accessed April 9 2021

**Table 6-2: Left Turn Warrant Analysis Results – Westbound**

<b>Highway 58 and Highway 88</b>						
<b>Horizon</b>	<b>Time Frame</b>	<b>Left Turn Volume (vehicles)</b>	<b>Volume Advancing (vehicles)</b>	<b>Volume Opposing (vehicles)</b>	<b>Analysis Intersection Treatment</b>	<b>Additional Left Turn Storage Required<sup>3</sup></b>
<b>2024 Post Development Traffic</b>	AM Peak	5	57	123	Type-II	Not Required
	PM Peak	6	57	162	Type-II	Not Required
<b>2034 Post Development Traffic</b>	AM Peak	6	68	146	Type-II	Not Required
	PM Peak	8	64	184	Type-II	Not Required
<b>2044 Post Development Traffic</b>	AM Peak	7	95	213	Type-II	Not Required
	PM Peak	9	69	204	Type-II	Not Required

<sup>3</sup> Alberta Transportation intersection analysis two-lane undivided highways (March 8, 2021)  
<https://open.alberta.ca/publications/traffic-impact-assessment-guidelines>, Accessed April 9 2021

### 6.1.2 Right Turn Warrant Analysis

To warrant an exclusive right turn lane at a two-lane highway intersection, the following three conditions must all be met:

- Main (or through) road AADT  $\geq$  1,800 vpd;
- Intersecting road AADT  $\geq$  900 vpd; and,
- Right turn daily traffic volume  $\geq$  360 vpd for the movement in question.

Based on a review of these criteria and under Post Development traffic conditions in the 2024, 2034 and 2044 horizons, exclusive eastbound and westbound right turn lanes are warranted for the intersection of Highway 58 and Highway 88. No Exclusive westbound right turn lane is warranted for the intersection of Highway 58 and East Access. A summary of the right turn warrant analysis is presented in **Table 6-3** and **Table 6-4**.

**Table 6-3: Right Turn Warrant Analysis Results – Eastbound**

Highway 58 and Highway 88							
Horizon	Main Road (Highway 58)		Intersecting Road (Highway 88)		EB Right turn		Right Turn Lane Warranted
	AADT (vpd)	AADT > 1800	AADT (vpd)	AADT > 900	AADT (vpd)	AADT > 360	
2024 Post Development Traffic	3,600	Yes	3,600	Yes	605	Yes	Yes
2034 Post Development Traffic	4,000	Yes	4,000	Yes	717	Yes	Yes
2044 Post Development Traffic	5,000	Yes	5,000	Yes	829	Yes	Yes

Note: vpd = vehicles per day; AADT = average annual daily traffic

**Table 6-4: Right Turn Warrant Analysis Results – Westbound**

Highway 58 and Highway 88							
Horizon	Main Road (Highway 58)		Intersecting Road (Highway 88)		EB Right turn		Right Turn Lane Warranted
	AADT (vpd)	AADT > 1800	AADT (vpd)	AADT > 900	AADT (vpd)	AADT > 360	
2024 Post Development Traffic	3,600	Yes	3,600	Yes	568	Yes	Yes
2034 Post Development Traffic	4,000	Yes	4,000	Yes	615	Yes	Yes
2044 Post Development Traffic	5,000	Yes	5,000	Yes	721	Yes	Yes
East Access							
Horizon	Main Road (Highway 652)		Intersecting Road (East Access)		EB Right turn		Right Turn Lane Warranted
	AADT (vpd)	AADT > 1800	AADT (vpd)	AADT > 900	AADT (vpd)	AADT > 360	
2044 Post Development Traffic	2,000	Yes	300	No	27	No	No

Note: vpd = vehicles per day; AADT = average annual daily traffic

### 6.1.3 Alberta Transportation Intersection Analysis Summary

Intersection treatment warrant analyses were completed for the intersections of Highway 58 with Highway 88 and East Access.

The completed left turn warrant analyses show the intersection of Highway 58 and Highway 88 will require a Type-IV treatment with a dedicated left turn lane in the eastbound direction and no additional storage length than provided with standard treatment. The existing intersection is classified as Type-IVa with additional north leg under construction which would bring the intersection to Type-IV. Since the intersection will have dedicated left turn lanes for both eastbound and westbound traffic, no additional upgrades for left turn traffic are identified at this stage. Right turn warrant analysis was also completed and showed that a dedicated right turn lane is warranted for the intersection of Highway 58 and Highway 88.

For Highway 58 and East Access intersection, no dedicated left turn or right turn lanes are warranted based on the analyses results.

Future TIA updates should be completed to confirm if additional upgrades are necessary based on the confirmed land-use proposed at the time of development application. The planned intersection design and typical Type-IV and Type-IIa treatment drawings are included in **Appendix D**.

## 6.2 SITE CIRCULATION AND ACCESS

Vehicular access into the site is planned via two accesses from Highway 58. As shown in **Appendix B**, the intersections are approximately 780 meters apart which exceeds the 400 meters indicated in AT-HGDC Table I.5 for Two-Lane Highway. It is noted an access to the existing single family residential property along the north side of the Highway 58 is located approximately 360 meters from the proposed East Access. The residential property access is expected to remain in place for the foreseeable future as the resident will continue occupying it. The spacing between the residential access and the east access is not anticipated to be an issue given the east access is not anticipated to be needed prior to 2044. As well, the residential access has limited traffic, consisting of primarily the occupant entering and exiting their property. Finally, the simple Type-IIa geometry of the proposed East Access has no turn lanes and would not require tapers that would be impacted by the residential access.

### 6.3 CAPACITY ANALYSIS

A Highway Capacity Manual (HCM) analysis was completed. Synchro Studio v11 was used to perform these calculations to determine intersection delays and levels of service.

Level of Service is based on the estimated average delay per vehicle for all traffic passing through an intersection. A good level of service is a result of a very low average delay; the highest level of service is identified as LOS A. A poor level of service is a result of a large average delay; typically, the lowest level of service is identified as LOS F. The level of service categories also varies depending on whether an intersection is signalized or stop- or yield- controlled. The Highway Capacity Manual justifies this difference by noting that drivers stopped at a signal light will have more tolerance for delays because their perception is that eventually they will get their turn, even with a longer wait. Poor level of service can contribute to drivers taking risks and proceeding unsafely into an intersection. **Table 6-5** identifies the level of service criteria for signalized and unsignalized intersections.

**Table 6-5: Level of Service Definition**

Level of Service	Average Signalized Control Delay per Vehicle (s)	Average Stop Control Delay per Vehicle (s)
A	less than 10	less than 10
B	10 – 20	10 – 15
C	20 – 35	15 – 25
D	35 – 55	25 – 35
E	55 – 80	35 – 50
F	greater than 80	greater than 50

The volume-to-capacity (v/c) ratio of an intersection describes the extent to which the traffic volumes can be accommodated by the theoretical physical capacity of the road configuration and traffic control. A v/c ratio less than 0.9 indicates that there is generally sufficient capacity to accommodate the traffic on the approach or at the intersection. A value between 0.9 and 1.0 suggests unstable operations and congestion may begin to occur as volumes are nearing the theoretical capacity of the roadway. A calculated value over 1.0 indicates that volumes are theoretically exceeding capacity. **Table 6-6** identifies the volume-to-capacity criteria for intersections.

**Table 6-6: Volume to Capacity Ratio Definition**

Volume-to-Capacity (v/c) Ratio	Indication
less than 0.9	sufficient intersection capacity
0.9 to 1.0	volumes approaching intersection capacity
greater than 1.0	volumes exceed theoretical intersection capacity

Typically, Alberta Transportation designs highway and rural roadways to an overall LOS C or better with the minor approach of LOS D or better. Therefore, for the purposes of this analysis, a minimum LOS C was required for the highway leg and minimum LOS D for the minor intersecting leg. The volume-to-capacity ratio should also be less than 0.9 for all approaches. All analyses generally use typical Synchro Studio default values, including a peak hour factor of 0.92. The heavy vehicle percentage is estimated at 10% for all movements based on existing AT traffic counts.

**6.3.1 Background Traffic - Capacity Analysis – All Horizons**

HCM analysis completed for the intersection of Highway 58 and Highway 88, and Range Road 135 with Phase 1 Access Road. The analysis shows that both study intersections would operate at acceptable LOS A in the AM and PM peak hours for 2024, 2034 and 2044 horizons based on Background traffic only. The analysis was completed assuming planned Type-IV treatment upgrades has been completed at the intersection of Highway 58 and Highway 88, and that the intersection is stop controlled on the north and south approaches. **Table 6-7, Table 6-8** and **Table 6-10** summarize the analysis results. Synchro summary reports are included in **Appendix E**.

**Table 6-7: 2024 Horizon Background Traffic Only**

Approach	Traffic Control	v/c Ratio	Total Delay (s)	Level of Service	95% Queue Length (m)
<b>HIGHWAY 88/RANGE ROAD 135 &amp; HIGHWAY 58</b>					
Eastbound Left	Free	0.00 (0.00)	7.5 (7.5)	A (A)	0.1 (0.1)
Eastbound Thru, Right		0.03 (0.04)	0.0 (0.0)	A (A)	0.0 (0.0)
Westbound Left	Free	0.00 (0.01)	7.6 (7.7)	A (A)	0.1 (0.1)
Westbound Thru, Right		0.01 (0.00)	0.0 (0.0)	A (A)	0.0 (0.0)
Northbound Left, Thru, Right	Stop	0.10 (0.09)	9.7 (9.7)	A (A)	2.4 (2.4)
Southbound Left, Thru, Right	Stop	0.01 (0.01)	9.3 (9.3)	A (A)	0.2 (0.3)
<b>Intersection</b>			<b>5.5 (5.2)</b>	<b>A (A)</b>	N/A
<b>RANGE ROAD 135 &amp; PHASE 1 ACCESS</b>					
Westbound Left, Thru, Right	Stop	0.01 (0.01)	8.8 (8.9)	A (A)	0.2 (0.3)
Northbound Left, Thru, Right	Free	0.01 (0.01)	0.0 (0.0)	A (A)	0.0 (0.0)
<b>Intersection</b>			<b>4.4 (4.4)</b>	<b>A (A)</b>	N/A

**Table 6-8: 2034 Horizon Background Traffic Only**

Approach	Traffic Control	v/c Ratio	Total Delay (s)	Level of Service	95% Queue Length (m)
<b>HIGHWAY 88/RANGE ROAD 135 &amp; HIGHWAY 58</b>					
Eastbound Left	Free	0.00 (0.00)	7.5 (7.5)	A (A)	0.1 (0.1)
Eastbound Thru, Right		0.03 (0.04)	0.0 (0.0)	A (A)	0.0 (0.0)
Westbound Left	Free	0.00 (0.01)	7.6 (7.7)	A (A)	0.1 (0.1)
Westbound Thru, Right		0.01 (0.00)	0.0 (0.0)	A (A)	0.0 (0.0)
Northbound Left, Thru, Right	Stop	0.10 (0.09)	9.7 (9.7)	A (A)	2.4 (2.4)
Southbound Left, Thru, Right	Stop	0.01 (0.01)	9.3 (9.3)	A (A)	0.2 (0.3)
<b>Intersection</b>			<b>5.5 (5.2)</b>	<b>A (A)</b>	N/A
<b>RANGE ROAD 135 &amp; PHASE 1 ACCESS</b>					
Westbound Left, Thru, Right	Stop	0.01 (0.01)	8.8 (8.9)	A (A)	0.2 (0.3)
Northbound Left, Thru, Right	Free	0.01 (0.01)	0.0 (0.0)	A (A)	0.0 (0.0)
<b>Intersection</b>			<b>4.4 (4.4)</b>	<b>A (A)</b>	N/A

**Table 6-9: 2044 Horizon Background Traffic Only**

Approach	Traffic Control	v/c Ratio	Total Delay (s)	Level of Service	95% Queue Length (m)
<b>HIGHWAY 88/RANGE ROAD 135 &amp; HIGHWAY 58</b>					
Eastbound Left	Free	0.00 (0.00)	7.5 (7.5)	A (A)	0.1 (0.1)
Eastbound Thru, Right		0.04 (0.06)	0.0 (0.0)	A (A)	0.0 (0.0)
Westbound Left	Free	0.01 (0.01)	7.7 (7.7)	A (A)	0.1 (0.2)
Westbound Thru, Right		0.01 (0.01)	0.0 (0.0)	A (A)	0.0 (0.0)
Northbound Left, Thru, Right	Stop	0.14 (0.14)	10.1 (10.1)	B (B)	3.7 (3.6)
Southbound Left, Thru, Right	Stop	0.01 (0.01)	9.4 (9.5)	A (A)	0.3 (0.3)
<b>Intersection</b>			<b>5.7 (5.4)</b>	<b>A (A)</b>	N/A
<b>RANGE ROAD 135 &amp; PHASE 1 ACCESS</b>					
Westbound Left, Thru, Right	Stop	0.01 (0.01)	8.8 (8.9)	A (A)	0.2 (0.3)
Northbound Left, Thru, Right	Free	0.01 (0.01)	0.0 (0.0)	A (A)	0.0 (0.0)
<b>Intersection</b>			<b>4.4 (4.4)</b>	<b>A (A)</b>	N/A



**6.3.2 Post Development Traffic 2024 - Capacity Analysis**

HCM analysis completed for the intersections of Highway 58 with Highway 88 and East Access, Range Road 135 with Phase 1 Access, and North Access. It is noted the North Access and the East Access are anticipated to be constructed by year 2044 only.

The analysis shows that intersections would operate at acceptable LOS B or better in the AM and PM peak hours for 2024, 2034 horizons based on Post Development traffic. By year 2044 the movements at the intersection of Highway 58 and Highway 88 would operate at LOS C during the AM and PM peak hours. The movements at the remaining intersections would operate at LOS A or better during both peak hours. **Table 6-10**, **Table 6-11** and **Table 6-12**. summarize the analysis results for the Post Development traffic volumes. Synchro summary reports are included in **Appendix E**.

**Table 6-10: 2024 Horizon Post Development Traffic**

Approach	Traffic Control	v/c Ratio	Total Delay (s)	Level of Service	95% Queue Length (m)
<b>HIGHWAY 88/RANGE ROAD 135 &amp; HIGHWAY 58</b>					
Eastbound Left	Free	0.06 (0.07)	7.8 (7.8)	A (A)	1.4 (1.8)
Eastbound Thru, Right		0.00 (0.01)	0.0 (0.0)	A (A)	0.0 (0.0)
Eastbound Right		0.03 (0.04)	0.0 (0.0)	A (A)	0.0 (0.0)
Westbound Left	Free	0.00 (0.01)	7.6 (7.7)	A (A)	0.1 (0.1)
Westbound Thru, Right		0.01 (0.00)	0.0 (0.0)	A (A)	0.0 (0.0)
Westbound Right		0.02 (0.03)	0.0 (0.0)	A (A)	0.0 (0.0)
Northbound Left, Thru, Right	Stop	0.29 (0.36)	14.2 (16.3)	B (C)	8.9 (12.1)
Southbound Left, Thru, Right	Stop	0.24 (0.38)	11.8 (14.1)	B (B)	7.0 (13.5)
<b>Intersection</b>			<b>9.3 (10.8)</b>	<b>A (A)</b>	N/A
<b>RANGE ROAD 135 &amp; PHASE 1 ACCESS</b>					
Westbound Left, Thru, Right	Stop	0.17 (0.01)	9.6 (8.9)	A (A)	4.7 (0.3)
Northbound Left, Thru, Right	Free	0.01 (0.01)	0.0 (0.0)	A (A)	0.0 (0.0)
<b>Intersection</b>			<b>9.0 (4.4)</b>	<b>A (A)</b>	N/A

**Table 6-11: 2034 Post Development Traffic**

Approach	Traffic Control	v/c Ratio	Total Delay (s)	Level of Service	95% Queue Length (m)
<b>HIGHWAY 88/RANGE ROAD 135 &amp; HIGHWAY 58</b>					
Eastbound Left	Free	0.07 (0.08)	7.8 (7.8)	A (A)	1.7 (2.0)
Eastbound Thru, Right		0.00 (0.01)	0.0 (0.0)	A (A)	0.0 (0.0)
Eastbound Right		0.03 (0.05)	0.0 (0.0)	A (A)	0.0 (0.0)
Westbound Left	Free	0.01 (0.01)	7.6 (7.7)	A (A)	0.1 (0.2)
Westbound Thru, Right		0.01 (0.00)	0.0 (0.0)	A (A)	0.0 (0.0)
Westbound Right		0.03 (0.03)	0.0 (0.0)	A (A)	0.0 (0.0)
Northbound Left, Thru, Right	Stop	0.37 (0.44)	16.3 (19.3)	C (C)	12.7 (16.9)
Southbound Left, Thru, Right	Stop	0.28 (0.46)	12.7 (15.9)	B (C)	8.6 (18.4)
<b>Intersection</b>			<b>10.1 (12.3)</b>	<b>B (B)</b>	N/A
<b>RANGE ROAD 135 &amp; PHASE 1 ACCESS</b>					
Westbound Left, Thru, Right	Stop	0.22 (0.35)	10.6 (11.9)	B (B)	6.3 (11.9)
Northbound Left, Thru, Right	Free	0.14 (0.16)	0.0 (0.0)	A (A)	0.0 (0.0)
<b>Intersection</b>			<b>4.6 (6.0)</b>	<b>A (A)</b>	N/A

**Table 6-12: 2044 Post Development Traffic**

Approach	Traffic Control	v/c Ratio	Total Delay (s)	Level of Service	95% Queue Length (m)
<b>HIGHWAY 88/RANGE ROAD 135 &amp; HIGHWAY 58</b>					
Eastbound Left	Free	0.11 (0.08)	8.0 (7.9)	A (A)	2.8 (2.1)
Eastbound Thru		0.01 (0.01)	0.0 (0.0)	A (A)	0.0 (0.0)
Eastbound Right		0.04 (0.05)	0.0 (0.0)	A (A)	0.0 (0.0)
Westbound Left	Free	0.01 (0.02)	7.7 (7.8)	A (A)	0.2 (0.4)
Westbound Thru		0.02 (0.01)	0.0 (0.0)	A (A)	0.0 (0.0)
Westbound Right		0.04 (0.03)	0.0 (0.0)	A (A)	0.0 (0.0)
Northbound Left, Thru, Right	Stop	0.69 (0.64)	31.9 (32.0)	D (D)	37.9 (32.1)
Southbound Left, Thru, Right	Stop	0.39 (0.73)	16.9 (27.1)	C (D)	13.9 (46.3)
<b>Intersection</b>			<b>16.3 (20.3)</b>	<b>C (C)</b>	N/A
<b>RANGE ROAD 135 &amp; PHASE 1 ACCESS</b>					
Westbound Left, Thru, Right	Stop	0.29 (0.44)	12.8 (14.9)	B (B)	9.1 (17.4)
Northbound Left, Thru, Right	Free	0.21 (0.17)	0.0 (0.0)	A (A)	0.0 (0.0)
Southbound Left, Thru, Right	Free	0.01 (0.01)	3.4 (0.8)	A (A)	0.2 (0.2)
<b>Intersection</b>			<b>4.3 (6.3)</b>	<b>A (A)</b>	N/A
<b>HIGHWAY 58 &amp; EAST ACCESS</b>					
Eastbound Left, Thru, Right	Free	0.02 (0.00)	2.6 (0.2)	A (A)	0.4 (0.1)
Westbound Left, Thru, Right	Free	0.06 (0.04)	0.0 (0.0)	A (A)	0.0 (0.0)
Southbound Left, Thru, Right	Stop	0.01 (0.04)	9.9 (9.9)	A (A)	0.1 (0.9)
<b>Intersection</b>			<b>1.3 (1.4)</b>	<b>A (A)</b>	N/A
<b>RANGE ROAD 135 &amp; NORTH ACCESS</b>					
Westbound Left, Thru, Right	Stop	0.02 (0.12)	9.2 (9.3)	A (A)	0.5 (3.1)
Northbound Left, Thru, Right	Free	0.07 (0.01)	0.0 (0.0)	A (A)	0.0 (0.0)
<b>Intersection</b>			<b>1.1 (8.2)</b>	<b>A (A)</b>	N/A

### 6.3.3 Post Development Traffic 2044 – Sensitivity - Capacity Analysis

A sensitivity analysis was completed to understand the operations of directing all traffic to the site through the intersection of Highway 58 and Highway 88. The analysis was completed for 2044 horizon only as the East Access is not anticipated before then. The results show that the intersection would operate at acceptable LOS C, and that all movements would operate at LOS D or better in the AM and PM peak hours. **Table 6-13** summarizes the analysis results for the Post Development traffic volumes. Synchro summary reports are included in **Appendix E**.

**Table 6-13: 2044 Post Development Traffic Sensitivity Analysis**

Approach	Traffic Control	v/c Ratio	Total Delay (s)	Level of Service	95% Queue Length (m)
<b>HIGHWAY 88/RANGE ROAD 135 &amp; HIGHWAY 58</b>					
Eastbound Left	Free	0.12 (0.09)	8.1 (7.9)	A (A)	3.0 (2.1)
Eastbound Thru		0.00 (0.01)	0.0 (0.0)	A (A)	0.0 (0.0)
Eastbound Right		0.04 (0.05)	0.0 (0.0)	A (A)	0.0 (0.0)
Westbound Left	Free	0.01 (0.01)	7.7 (7.7)	A (A)	0.1 (0.2)
Westbound Thru		0.01 (0.00)	0.0 (0.0)	A (A)	0.0 (0.0)
Westbound Right		0.05 (0.03)	0.0 (0.0)	A (A)	0.0 (0.0)
Northbound Left, Thru, Right	Stop	0.70 (0.62)	34.1 (29.9)	D (D)	39.4 (30.2)
Southbound Left, Thru, Right	Stop	0.40 (0.73)	17.1 (26.3)	C (D)	14.6 (46.7)
<b>Intersection</b>			<b>17.1 (19.9)</b>	<b>C (C)</b>	N/A
<b>RANGE ROAD 135 &amp; PHASE 1 ACCESS</b>					
Westbound Left, Thru, Right	Stop	0.31 (0.47)	13.4 (15.8)	B (C)	9.8 (18.7)
Northbound Left, Thru, Right	Free	0.23 (0.17)	0.0 (0.0)	A (A)	0.0 (0.0)
Southbound Left, Thru, Right	Free	0.01 (0.1)	2.9 (0.7)	A (A)	0.2 (0.2)
<b>Intersection</b>			<b>4.3 (6.3)</b>	<b>A (A)</b>	N/A
<b>RANGE ROAD 135 &amp; NORTH ACCESS</b>					
Westbound Left, Thru, Right	Stop	0.03 (0.15)	9.3 (9.5)	A (A)	0.6 (4.0)
Northbound Left, Thru, Right	Free	0.09 (0.01)	0.0 (0.0)	A (A)	0.0 (0.0)
<b>Intersection</b>			<b>1.1 (8.3)</b>	<b>A (A)</b>	N/A

### 6.3.4 Capacity Analysis Summary

Based on analyses results, the study intersections are anticipated to operate at an acceptable LOS C or better, with all movements anticipated to operate at LOS D or better during both peak hours following the complete development of the site by 2044. Free flow traffic, eastbound and westbound, travelling along highway 58 is expected to experience little to no delay. Northbound and southbound traffic is expected to have limited delays however the overall approaches are expected to continue to operate at an acceptable level of service.

## 6.4 ROADWAY CROSS SECTION AND DAILY VOLUME

The daily traffic volume anticipated at the full build out of the site was estimated based on daily trip rates provided in the ITE Trip Generation Manual for the anticipated land-uses as indicated in **Section 4.1**. A summary of the anticipated daily volumes is shown in **Figure 6-1**.

The Mackenzie County Rural Road, Access Construction and Surface Water Management Policy (PW039), shows that two road cross-sections are generally provided within the county, Collector Road and Local Road. Given the planned industrial land use within the area, the Collector Road standard would provide the appropriate width and capacity for the future traffic as it is recommended for roads with Average Annual Daily Traffic of more than 200 vehicles per day. A copy of the County's standard is attached in **Appendix G**.

**Figure 6-1: Forecasted Daily Traffic Volume at Site Build Out**

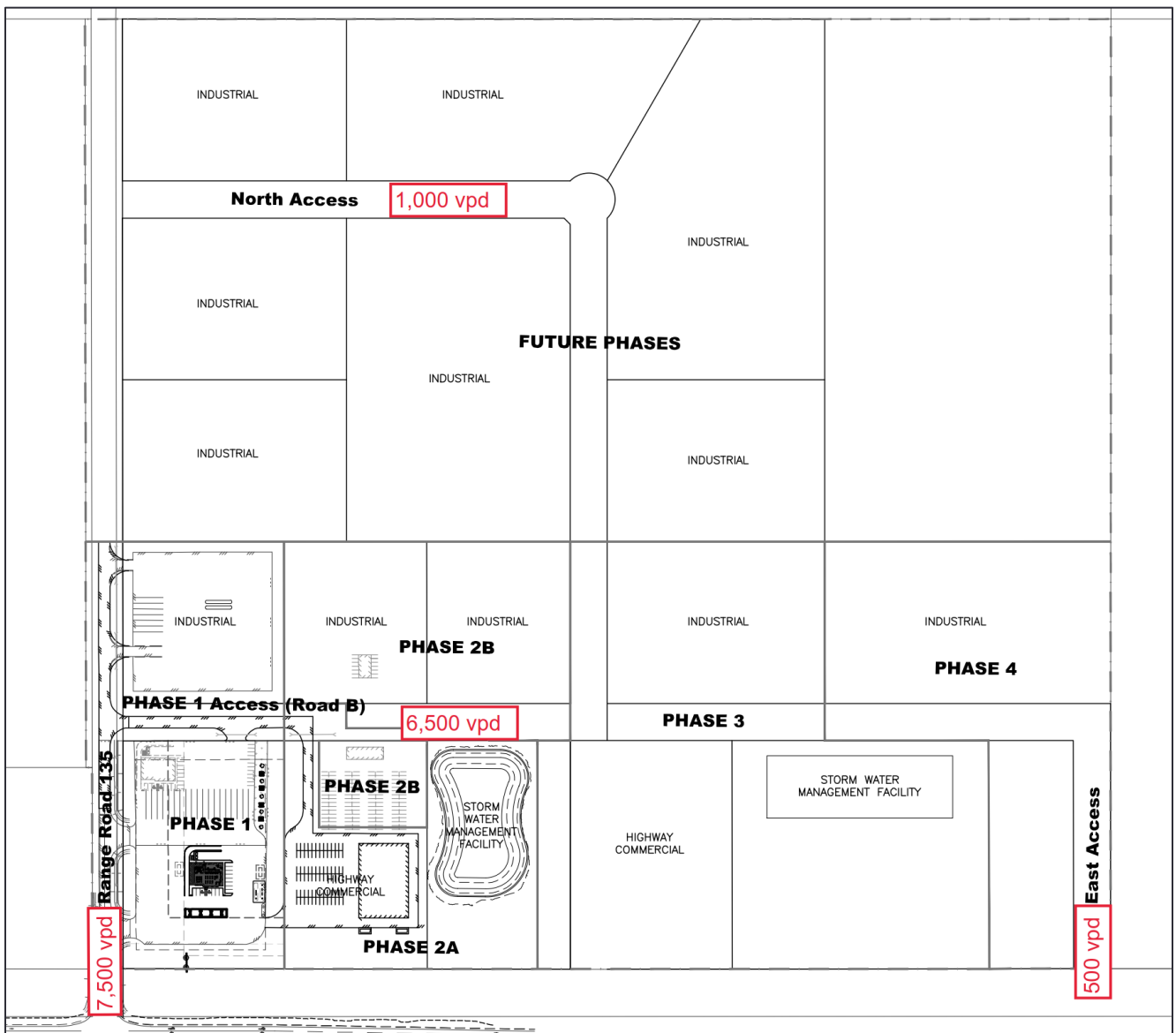

## 6.5 ILLUMINATION WARRANT

A lighting assessment was completed at the intersections of Highway 58 with Highway 88 and the East Access using the TAC Illumination of Isolated Rural Intersections (2001). TAC warrant calculations are completed with the following general thresholds for lighting:

- Full Illumination – 240 points or more;
- Partial or Delineation Lighting – 120 to 239 points; and
- No Illumination – less than 120 points.

Full illumination denotes covering an intersection in a uniform manner over the traveled portion of the roadway. Partial lighting refers to the illumination of key decision areas, potential conflict points, and/or hazards in or on the approach to the intersection. Delineation lighting refers to “sentry” lighting that marks an intersection location for approaching traffic, for the illumination of vehicle on a cross street.

If at least 80 of the minimum 120 points are achieved in the Geometric score, partial lighting should be considered. If 120 points or more is achieved in the Operational score, delineation lighting should be considered. If 120 points are achieved in the Collision score, a review of collision history should be conducted to identify the cause of collision. If the causes cannot be rectified, partial or delineation lighting may be considered to address collisions that may be avoided by improved lighting.

According to the collision history provided in AT Online Map (TIMS and NESS), there were four collisions from 2010 to 2020 near the intersection of Highway 58 and Highway 88. The four collisions were categorized as nighttime collisions, however, as noted in the time of collision, two occurred between 5 and 6 a.m. and two occurred between 6 and 7 p.m. All collisions occurred during the months of January, February and November when the day light hours are shorter. The collision data does not provide detail on whether any of the collisions were weather related so as a conservative assumption, it was assumed that the four collisions were related to the lighting.

As well, there was four collisions from 2010 to 2020 near the intersection of Highway 58 and the future East Access. Three of collisions were categorized as nighttime, occurring between November and January when the day light hours are shorter. The data indicated that the collisions were a result of obstruction appearing suddenly in the road such as animal crossing. Therefore, collisions were not attributed to lighting as no systemic trend was established.

As delineation lighting is already part of the approved Phase 1 improvements (please refer to memorandum submitted by Urban Systems, May 2020 for details), no additional illumination is required for future phases. A summary of the Lighting Warrant results is shown in **Table 6-14**. The TAC Warrant worksheets are included in **Appendix E**.

**Table 6-14: Summary of Illumination Warrant Results**

Highway 58 and Highway 88						
Horizon	Geometric Score	Operational Score	Environmental Score	Collision Score	Total Score	Type of Illumination
2024 Post Development	6	160	5	15	186	Partial/Delineation
2034 Post Development	6	160	5	15	186	Partial/Delineation
2044 Post Development	6	170	5	15	196	Partial/Delineation
Highway 58 and East Access						
Horizon	Geometric Score	Operational Score	Environmental Score	Collision Score	Total Score	Type of Illumination
2044 Post Development	3	50	5	15	73	None

## 6.6 SIGNALIZATION WARRANT

Signalization warrant analysis was completed to determine if signalization is warranted for the intersection of Highway 58 and Highway 88. Signals are considered warranted if the score exceeds 100 points. Using the permanent automated traffic recorder located approximately 1.1 km east of Highway 58 and Highway 88 intersection, the ratio between the combined six peak hours of traffic to the combined AM and PM peak hours of traffic was calculated at approximately 2.7. This ratio was then applied to Post Development traffic volumes at year 2044 as it represents the worse case scenario to determine if signalization is warranted. The analysis score shows 82 points therefore signalization is not warranted at this stage. Since it is not warranted for 2044, it is not anticipated to be warranted for the earlier study horizons as the 2044 represents a worse scenario. The result of the signal warrant is attached in **Appendix H**.

## 6.7 PEDESTRIAN WARRANT ANALYSIS

The surrounding area of the site is rural and relatively isolated from any nearby development, and with no presence of pedestrian facilities such as separated sidewalks or pathways. The proposed development is not pedestrian-oriented, with all future clients and employees anticipated to access it using personal and heavy motor vehicles. Therefore, no pedestrian warrant analysis was completed.

## 6.8 EXISTING SAGS AND CRESTS

No existing sags or crests were identified within the development study area.

## 6.9 INTERSECTION SIGHT DISTANCE

According to Alberta Transportation Highway Geometric Design Guide, the intersection sight distance for left turn vehicles onto a highway is the minimum sight distance required along a main (or through) highway at intersections necessary to permit the stopped vehicle to turn left onto the main (or through) two-lane highway<sup>4</sup>.

Given that Highway 58 is an undivided, two-lane highway at Highway 88 and at the East Access with no median to allow vehicles to complete the turn in two steps, Figure D-4.2.2.2 was used as indicated in Section D.4.2.2.2 of the AT Highway Geometric Design Guide. The assessment was completed using WB-21 vehicle as design vehicle as it is the suggested vehicle for major intersections and is expected to be present frequently at the site.

At Highway 88/Range Road 135 Access, using Figure D-4.2.2.2 of the AT Highway Geometric Design Guide, the required intersection sight distance for traffic is approximately 560 meters for a WB-21 Truck to complete a left turn onto Highway 58 assuming design speed of operating speed of 110 km/hr (posted speed of 100 km/hr). At the subject intersection, sight distance is over 560 meters in both directions.

At East Access, using Figure D-4.2.2.2 of the AT Highway Geometric Design Guide, the required intersection sight distance for traffic is approximately 460 meters for a WB-21 Truck to complete a left turn onto Highway 58 based on design speed of 90 km/hr (posted speed of 80 km/hr). At the subject intersection, sight distance is over 560 meters in both directions.

## 6.10 STOPPING SIGHT DISTANCE

Stopping sight distance is the minimum sight distance available on a roadway to allow a vehicle to stop before reaching a stationary object in its path.

At the Highway 58 and Highway 88 access and using Table B-2-3a of the AT Highway Geometric Design Guide, the minimum stopping sight distance for design speed of 110 km/hr (posted speed of 100 km/hr) is 220 meters. At the subject intersection, sight distance is over 560 meters in both directions.

At the Highway 58 and East Access and using Table B-2-3a of the AT-HGDG, the minimum stopping sight distance for design speed of 90 km/hr (posted speed of 80 km/hr) is 160 meters. At the subject intersection, sight distance is over 560 meters in both directions.

## 6.11 COLLISIONS REVIEW

A historic review of collision information along the Highway 58 segment between Highway 88 and the future East Access for the site was completed to understand the safety of the road. The data reviewed shows a total of eight collisions occurring between 2010 and 2020. The collisions, however, were primarily a result of driver judgment error or uncontrolled wild animals reaching the highway. Therefore, no geometric improvements are recommended at this point due to the collision history. Partial delineation might be necessary as described in **Section 6.5**.

<sup>4</sup>Alberta Transportation Highway Geometric Design Guide Chapter D – June 1999  
Alberta Transportation Highway Geometric Design Guide Chapter B – September 2020

## 7.0 RECOMMENDATIONS & CONCLUSIONS

Urban Systems Ltd. (USL) was retained by Little Red River Cree Nation (LRRCN) to complete an Area Structure Plan (ASP) of the quarter section of land located in the northeast corner of the intersection of Highway 58 and Highway 88, also known as Caribou Mountain Commercial Park. **Figure 2-1** shows the proposed site location.

This study analyzed the intersections described in **Section 2.1** over the anticipated construction horizons of 2024, 2034 and 2044. Existing traffic volume was estimated using Alberta Transportation (AT) available traffic counts and the approved Phase 1 development traffic volume as provided in the “Caribou Mountain Travel Center Response to TIA comments”, May 2020 Memorandum and the Institute of Transportation Engineer (ITE) Land-Use Code 110 for General Light Industrial which is the anticipated use of gas storage facility.

An annual growth rate for the Highway 58 and Highway 88 traffic volume is calculated using historical Alberta Transportation traffic counts from the intersection of Highway 58 and Highway 88 (Count Reference Number 39960). The calculated historical annual growth rate shows that the through traffic along Highway 58 and Highway 88 increased linearly by 1.2% and 1.1% per year over the past 19 years, respectively. As a conservative approach and per discussion with AT, the future background through traffic volumes along Highway 58 and Highway 88 are grown by 2% linearly per year to the 2024, 2034 and 2044 horizon years. Traffic turning north at the intersection was not adjusted by the mentioned rate as future growth would be driven developments within the Caribou Mountain Commercial Park.

The study utilizes multiple land-use codes from the ITE Trip Generation Manual to estimate the total future traffic generated by the multiple phases of the site. This study relies on the anticipated land uses at the time of completing this study. Future traffic impact assessment updates that build on this study may be required at each phase of development approval, at which time the proposed land use should be confirmed. The Floor Area Ratio (FAR) is assumed to be 10% on all industrial sites based on similar type of developments in rural areas across Alberta.

Based on the analyses completed, the following are the improvements recommended at intersection of Highway 58 with Highway 88 and East Access.

- Dedicated right turn lanes are warranted at the intersection of Highway 58 and Highway 88. The upgrades should be completed after monitoring of traffic growth at the intersection to determine the proper timing of construction.
- Partial/Delineation lighting to be installed at the intersection of Highway 58 and Highway 88 at opening day and all analyzed horizons. As delineation lighting is already part of the approved Phase 1 improvements (please refer to memorandum submitted by Urban Systems, May 2020 for details), no additional illumination is required for future phases.
- The proposed East Access would operate at acceptable level of service with Type-IIa treatment



## 8.0 AUTHORIZATION & CLOSING

This document entitled "Caribou Mountain Commercial Park ASP – Traffic Impact Assessment" was prepared by Urban Systems for the account of Little Red River Cree Nation. The material in it reflects Urban's best judgment in light of the information available to it at the time of preparation. Any use which a third party, beyond Alberta Transportation, makes of this report, or reliance on or decisions made based on it, are the responsibilities of such third parties. Urban Systems accepts no responsibilities for damages, if any, suffered by such third parties as a result of decisions made or actions based on this report.

Respectfully submitted,

URBAN SYSTEMS LTD.

PREPARED BY:

Saeed Bashi, P. Eng.  
Transportation Engineer

REVIEWED BY:

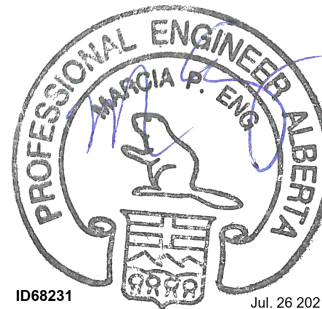

Marcia Eng, P. Eng.  
Senior Transportation Engineer

### PERMIT TO PRACTICE URBAN SYSTEMS LTD.

RM SIGNATURE: *[Signature]*

RM APEGA ID #: 80017

DATE: 2021-07-27

**PERMIT NUMBER: P003836**

The Association of Professional Engineers and  
Geoscientists of Alberta (APEGA)

# APPENDIX A:

# ALBERTA TRANSPORTATION CORRESPONDENCE

## Saeed Bashi

---

**From:** TRANS Development Peace River <TRANSDevelopmentPeaceRiver@gov.ab.ca>  
**Sent:** Thursday, June 10, 2021 10:03 AM  
**To:** Saeed Bashi  
**Cc:** Marcia Eng; Dylan Smith; Danny Jung; Mary Crowley  
**Subject:** RE: Proposed TIA Scope for Quarter Section ASP

CAUTION: External Email.

Good Morning Saeed,

Thank you for your email. We have reviewed your proposal and can offer the following comments.

- Alberta Transportations standards for TIA can be found here <https://open.alberta.ca/dataset/0bdbdd46-06f4-4345-8768-d68b8306444e/resource/d5996230-5d08-40d9-a8dc-bec68018b1a4/download/trans-traffic-impact-assessment-guidelines-2021-02.pdf>, these standards must be met. If you are proposing to use different standards such as growth rate, you must first demonstrate why you feel this is necessary.
- The Department will not permit the construction of two additional direct highway accesses to the site, we **MAY** consider an access at the east boundary as shown on the plan provided, if supported by the revised TIA.

If you have any questions or would like to discuss please let me know.

Marlene Cobick  
Development and Planning Technologist  
Alberta Transportation – Peace Region  
Office: 780-624-6372  
Cell: 780-618-8168  
*A little appreciation goes a long way. Thank someone today with an [ecard!](#)*

Classification: Protected A

---

**From:** Saeed Bashi <sbashi@urbansystems.ca>  
**Sent:** Tuesday, June 01, 2021 1:20 PM  
**To:** Marlene Cobick <Marlene.Cobick@gov.ab.ca>  
**Cc:** Marcia Eng <MEng@urbansystems.ca>; Dylan Smith <dsmith@urbansystems.ca>  
**Subject:** Proposed TIA Scope for Quarter Section ASP

CAUTION: This email has been sent from an external source. Treat hyperlinks and attachments in this email with care.

Hello Marlene,

We are working with Little Red River Cree Nation on completing an Area Structure Plan (ASP) of the quarter section of land located at the intersection of Highway 58 and Highway 88. The ASP parcel area is located in the northeast corner of the intersection (Google Maps <https://goo.gl/maps/eXg4yPKwgPZA8wTBA>) and has the proposed site layout attached. The parcel currently has Phase 1 area under construction with expected completion date by the end of 2021. The roadside development permit for Phase 1 was submitted and approved in May 2020.

As part of completing the ASP for the remaining phases, we are proposing to complete a full Traffic Impact Assessment (TIA) that evaluates the impact of the future traffic growth on the surrounding highway network. The study would build

on previously completed work as submitted in the Phase 1 memo attached. Below is a summary of the proposed TIA scope for the ASP area:

- Study horizons  
Based on the attached site layout and development phasing plan shown, the study horizons would be
  - Phase 2A - Opening day (2022),
  - Phase 2B - 10 years (2032),
  - Phase 3, 4 and Future Phases - 20 years (2042)
- Background traffic volume growth
  - Utilize available traffic counts completed by Alberta Transportation to establish existing background volume at the intersection of Highway 58 and Highway 88.
    - Phase 1 development traffic volumes, as indicated in the attached memo, would be included in the background traffic for the study horizons but would not have any growth applied since the development volumes would only grow from additional development.
  - Original highway growth assumptions for Highway 58 and Highway 88, as extracted from AT traffic database, was 1.6% and 1.2% annually for Highway 58 and Highway 88 respectively.
    - We understand that both rates have been accepted by the department in the past as part of the approval for Phase 1 development, a copy of the memo is attached in this email. We are proposing to continue using these average annual noncompound growth rates to maintain consistent background traffic growth forecast.
- Study intersections
  - Highway 58/Highway 88
  - Highway 58/middle site access
  - Highway 58/east site access
  - North-South Range Road/north site access
  - North-South Range Road/Phase 1 site access
  - Note: AT warrants to be completed only for intersections along the highway
- Proposed land uses and ITE Land use Codes (As per attached Site Plan)
  - Phase 2A - Grocery store (Supermarket, ITE Land Use 850)
  - Phase 2B
    - Quick Service Restaurant (Fast Food Restaurant, ITE Land Use 934)
    - Vehicle Service (Vehicle Shop, ITE Land Use 941)
    - Card Lock (Gasoline/Service Station, ITE Land Use 944)
  - Phase 3, 4 and Future Phases
    - Highway Commercial: assume similar uses to Phase 1 and 2 which include fast-food restaurant, gas station and/or potential motel. Associate ITE rates will be used.
    - General Light Industrial (ITE Land Use 110): Assume 10% Floor Area Ratio (FAR) on all industrial sites based on similar industrial developments in rural areas.
- Analysis will be completed for background and post development condition. Analysis to include:
  - AM and PM peak hour intersection operational analysis using Synchro V11
  - Alberta Transportation's left turn lane warrant and right turn lane warrant at highway study intersections
  - Sight distance analysis at study intersections along highway
  - Illumination warrants at highway study intersections
  - Traffic signal warrants – if traffic signals are warranted along highway, would need to explore possible alternatives including roundabout, prior to recommending signals.
- Assume no pedestrian accommodations required along the highway or crossing highway due to the remote nature of the site.

Please feel free to contact me if you have any questions.

Best,

**Saeed Bashi, P.Eng.**  
Transportation Engineer

101-134 11<sup>th</sup> Avenue SE | Calgary, AB T2G 0X5  
**t** 403-291-1193 x4314 | **c** 306-880-5214  
**w** [urbansystems.ca](http://urbansystems.ca)



# TIA Summary Chart

<b>Date</b>	July 26 2021	<b>Consultant</b>	Urban Systems Ltd
<b>Project</b>	Caribou Mountain Commercial Park ASP - Traffic Impact Assessment		

## Site Information

<b>Development Type</b>	Commercial Park - Area Structure Plan		
<b>Highway No.</b>	58 and 88	<b>Control Section</b>	58:08 and 88:18
<b>Legal Land Description</b>	SW...-5-110-13-W5M		
<b>Posted Speed</b>	100	<b>Design Speed</b>	110
<b>Design Vehicle (include turning templates in appendix)</b>	<b>WB 21</b>		
<b>Sight Distance Available</b>	over 560 meters	<b>Min. Requirement</b>	560 m
<b>Lane Configuration</b>	East/West: Shared Thru/right, Dedicated left. North/South: Shared All		
<b>Existing Right of Way Width</b>	53.75 m from Highway 58 centre line		

## Warrants

	Existing	Improvement Required	
		Interim	Ultimate
<b>Year</b>		2024	2044
<b>Left Turn Lane</b>		Warranted	Warranted
<b>Right Turn Lane</b>		Warranted	Warranted
<b>Signal/Roundabout</b>		Not warranted	Not warranted
<b>Illumination (please specify)</b>		Partial/Delineation	Partial/Delineation
<b>Pedestrian</b>		Not required	Not required

## Intersection Treatment

	Existing	Proposed
<b>Intersection Treatment Type</b>	Type-IV	Type-IV
<b>Additional Modifications</b>		Dedicated right turn lanes
<b>Design Constraints</b>		N/A

## Additional Comments

The above identified improvements are for the intersection of Highway 58 and Highway 88. The study also proposes an additional access to the site which, if approved, is proposed as Type-II intersection. Additional details on the analysis methodology is included in the study.

*Disclaimer: Please note this chart does not summarize all of the guideline requirements and does not mean the categories not listed here can be excluded from the TIA*

# APPENDIX B: SITE PLAN

**FIGURE 2-1**

- LEGEND
- PROJECT BOUNDARY
  - PROPOSED LOT LINE
  - WETLAND
  - WETLAND BUFFER
  - PHASE LINE

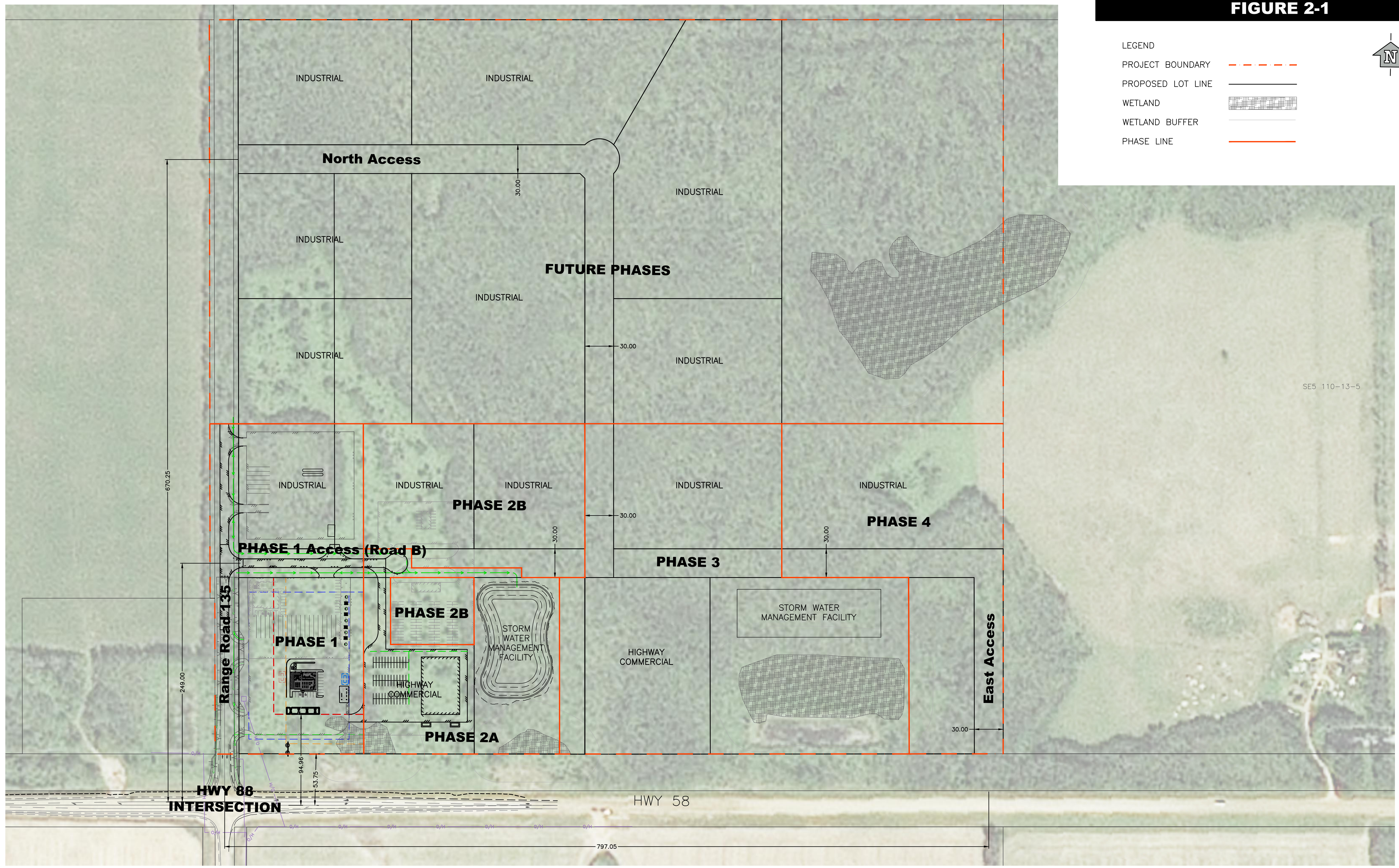
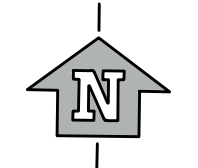

U:\Projects\_EDM\2847001\501\1D-Design\CAD\20\_PROD\FIG\Fig-2847001-1301-1-LOCATION & PHASING OF THE PROJECT DEVELOPMENT.dwg, ASP, 2021/07/19 05:02 pm saibong



# APPENDIX C:

## LEFT TURN WARRANT ANALYSIS – ALBERTA TRANSPORTATION



## Intersection Analysis Rural Two-Lane Undivided Highways

Main Rd: Highway 58  
Minor Rd: Highway 88

Direction: Eastbound  
Period: AM. Peak

Year of Analysis: 2024  
Date of Analysis: 18-Jun-2021

INPUT	Value
85 <sup>th</sup> percentile speed, km/h:	100
Main Road A.A.D.T.	4,000
Minor (intersecting) Road A.A.D.T	4,000
Left turn volume ( $V_{LT}$ ), veh/h:	73
Advancing volume ( $V_{adv}$ ), veh/h:	123
Opposing volume ( $V_{opp}$ ), veh/h:	57
Left turn truck volume, trucks/h:	25
Right turn volume ( $V_{RT}$ ), veh/day:	605

OUTPUT	Value
Percent left-turns in advancing volume:	59.3%
Percent trucks in left turn volume:	34.2%
Probability of conflict threshold:	0.89%
Calculated probability of conflicting arrival:	0.3%
Calculated conflicts per hour, veh/h:	0.3

Use Detailed Method

Type II

RT Lane  
warranted

Additional Storage Not Required	base storage requirement		-
	- standard storage length		-
	+ additional truck storage		-
	= total additional storage required		-

### CALIBRATION CONSTANTS

Variable	Value
Average time for making left-turn, s:	3.0
Critical headway (gap), s:	5.0
Average time to clear, s:	1.9

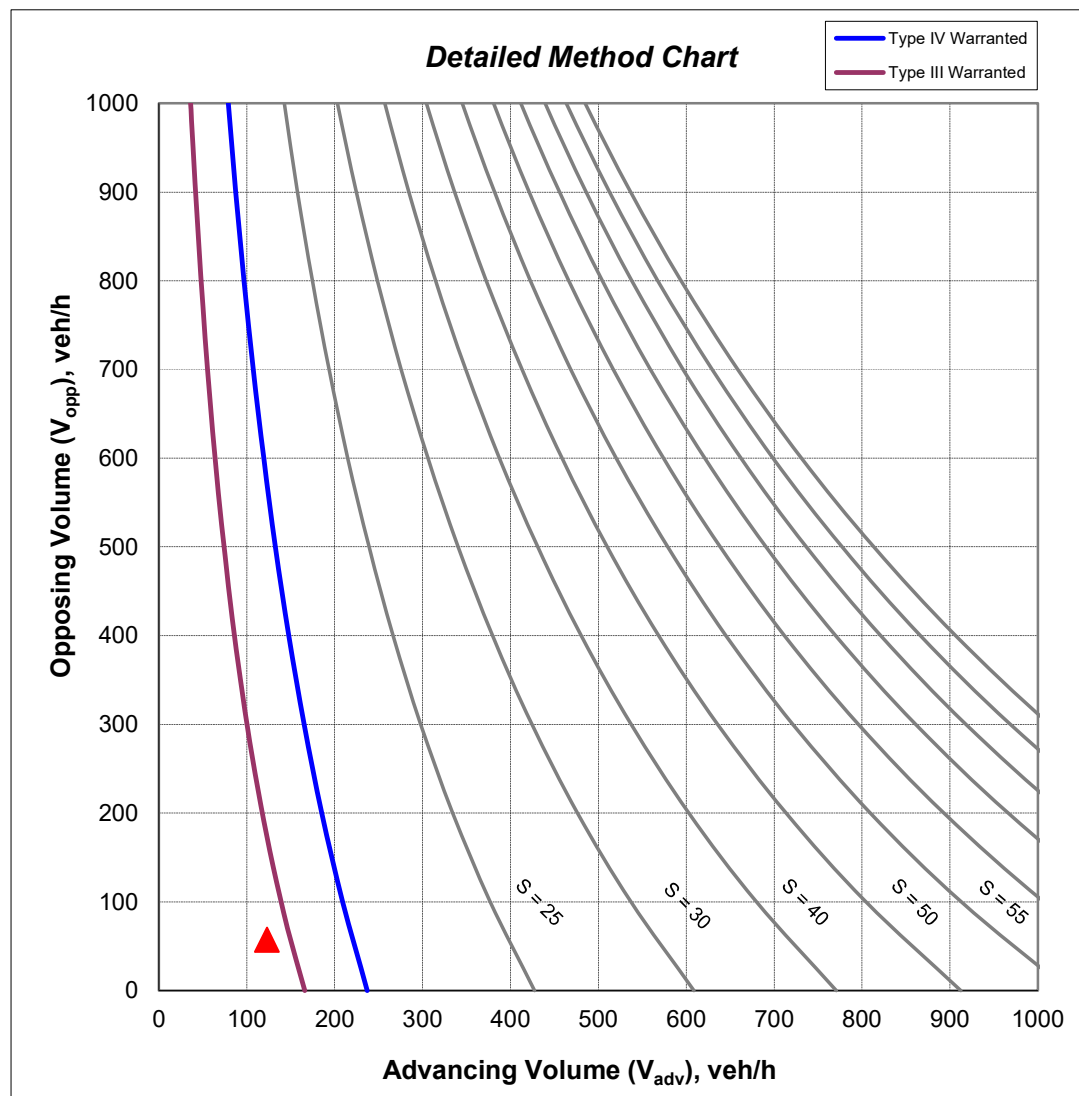



## Intersection Analysis Rural Two-Lane Undivided Highways

Main Rd: Highway 58  
Minor Rd: Highway 88

Direction: Eastbound  
Period: PM. Peak

Year of Analysis: 2024  
Date of Analysis: 18-Jun-2021

INPUT	Value
85 <sup>th</sup> percentile speed, km/h:	100
Main Road A.A.D.T.	4,000
Minor (intersecting) Road A.A.D.T	4,000
Left turn volume ( $V_{LT}$ ), veh/h:	92
Advancing volume ( $V_{adv}$ ), veh/h:	162
Opposing volume ( $V_{opp}$ ), veh/h:	57
Left turn truck volume, trucks/h:	30
Right turn volume ( $V_{RT}$ ), veh/day:	605

OUTPUT	Value
Percent left-turns in advancing volume:	56.8%
Percent trucks in left turn volume:	32.6%
Probability of conflict threshold:	0.89%
Calculated probability of conflicting arrival:	0.5%
Calculated conflicts per hour, veh/h:	0.8

Use Detailed Method

Type III

RT Lane  
warranted

Additional Storage Not Required	base storage requirement		-
	- standard storage length		-
	+ additional truck storage		-
	= total additional storage required		-

### CALIBRATION CONSTANTS

Variable	Value
Average time for making left-turn, s:	3.0
Critical headway (gap), s:	5.0
Average time to clear, s:	1.9

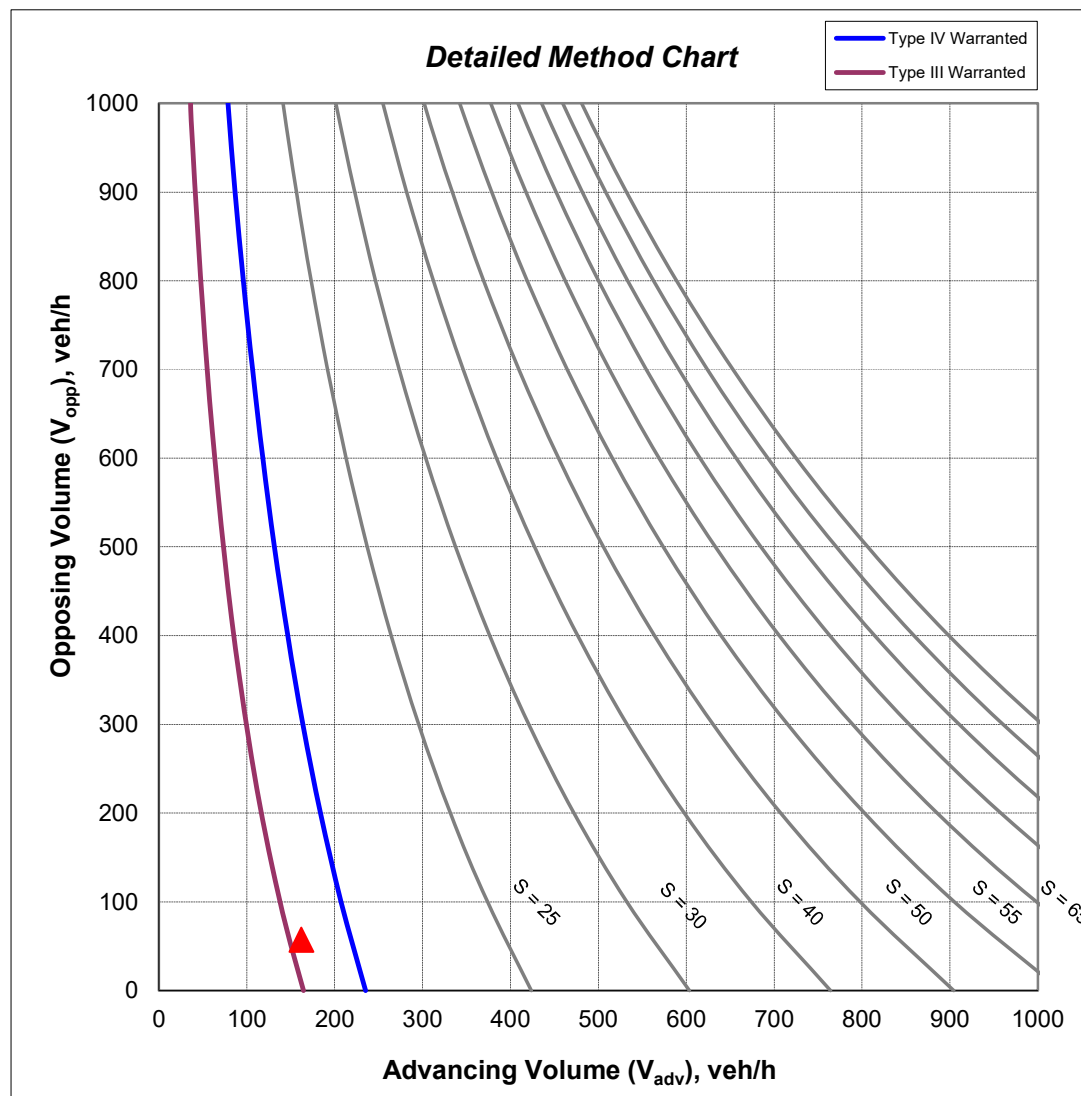



## Intersection Analysis Rural Two-Lane Undivided Highways

Main Rd: Highway 58  
Minor Rd: Highway 88

Direction: Westbound  
Period: AM. Peak

Year of Analysis: 2024  
Date of Analysis: 18-Jun-2021

INPUT	Value
85 <sup>th</sup> percentile speed, km/h:	100
Main Road A.A.D.T.	4,000
Minor (intersecting) Road A.A.D.T	4,000
Left turn volume ( $V_{LT}$ ), veh/h:	5
Advancing volume ( $V_{adv}$ ), veh/h:	57
Opposing volume ( $V_{opp}$ ), veh/h:	123
Left turn truck volume, trucks/h:	2
Right turn volume ( $V_{RT}$ ), veh/day:	568

OUTPUT	Value
Percent left-turns in advancing volume:	8.8%
Percent trucks in left turn volume:	40.0%
Probability of conflict threshold:	0.89%
Calculated probability of conflicting arrival:	0.0%
Calculated conflicts per hour, veh/h:	0.0

Use Detailed Method

Type II

RT Lane  
warranted

Additional Storage Not Required	base storage requirement		-
	- standard storage length		-
	+ additional truck storage		-
	= total additional storage required		-

### CALIBRATION CONSTANTS

Variable	Value
Average time for making left-turn, s:	3.0
Critical headway (gap), s:	5.0
Average time to clear, s:	1.9

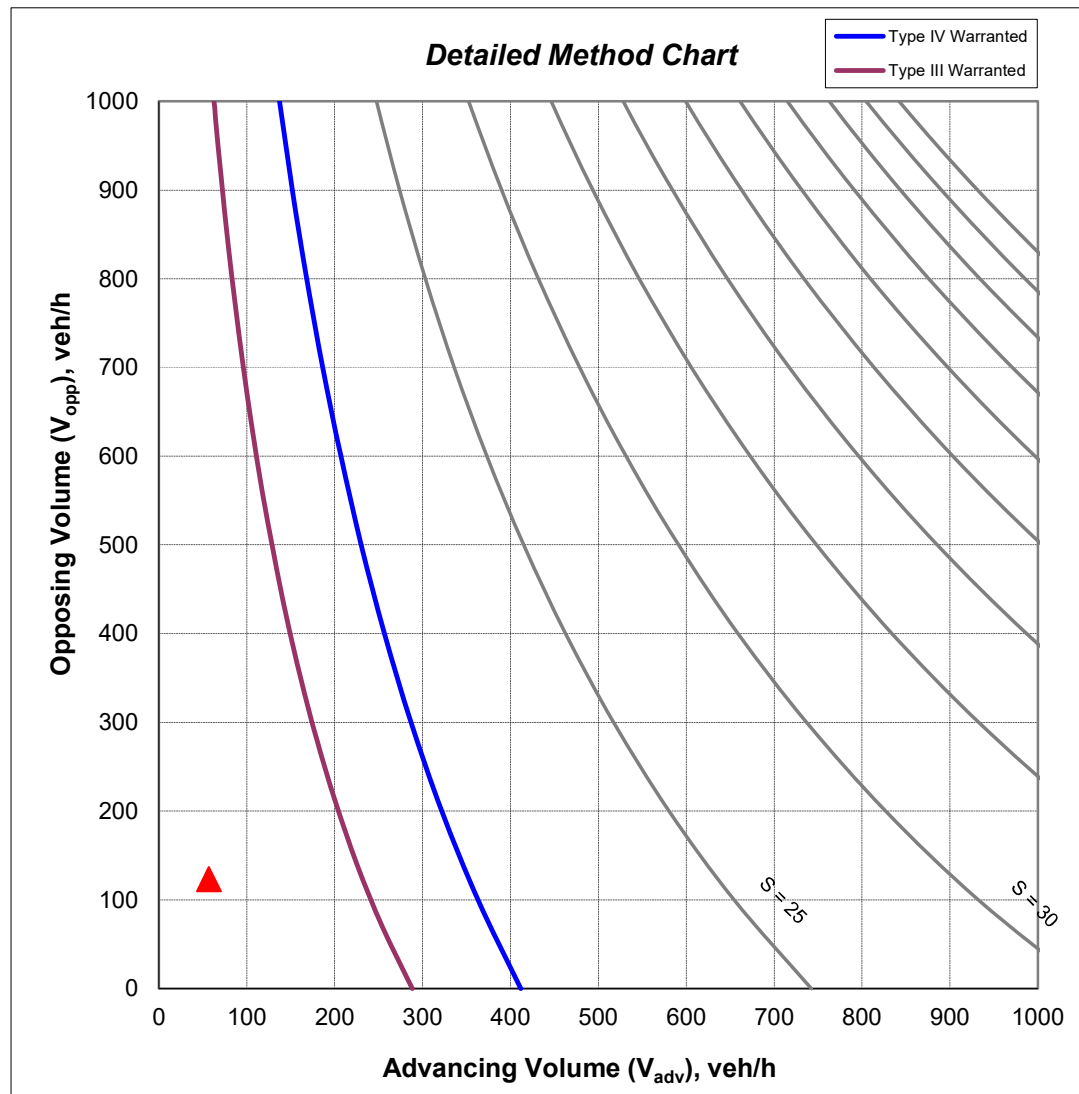



## Intersection Analysis Rural Two-Lane Undivided Highways

Main Rd: Highway 58  
Minor Rd: Highway 88

Direction: Westbound  
Period: PM Peak

Year of Analysis: 2024  
Date of Analysis: 18-Jun-2021

INPUT	Value
85 <sup>th</sup> percentile speed, km/h:	100
Main Road A.A.D.T.	4,000
Minor (intersecting) Road A.A.D.T	4,000
Left turn volume ( $V_{LT}$ ), veh/h:	6
Advancing volume ( $V_{adv}$ ), veh/h:	57
Opposing volume ( $V_{opp}$ ), veh/h:	162
Left turn truck volume, trucks/h:	2
Right turn volume ( $V_{RT}$ ), veh/day:	568

OUTPUT	Value
Percent left-turns in advancing volume:	10.5%
Percent trucks in left turn volume:	33.3%
Probability of conflict threshold:	0.89%
Calculated probability of conflicting arrival:	0.0%
Calculated conflicts per hour, veh/h:	0.0

Use Detailed Method

Type II

RT Lane  
warranted

Additional Storage Not Required	base storage requirement		-
	- standard storage length		-
	+ additional truck storage		-
	= total additional storage required		-

### CALIBRATION CONSTANTS

Variable	Value
Average time for making left-turn, s:	3.0
Critical headway (gap), s:	5.0
Average time to clear, s:	1.9

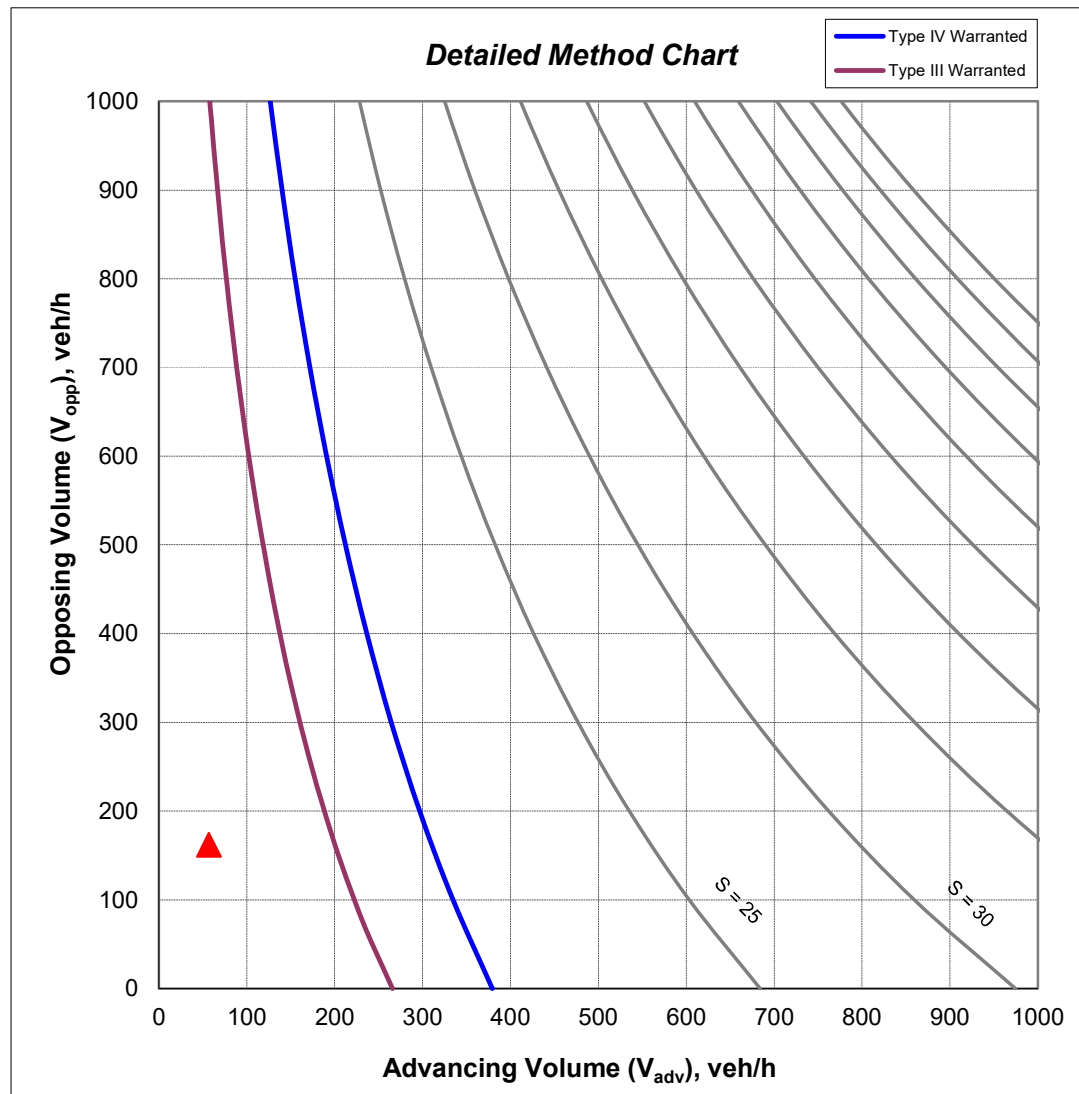



## Intersection Analysis Rural Two-Lane Undivided Highways

Main Rd: Highway 58  
Minor Rd: Highway 88

Direction: Eastbound  
Period: AM Peak

Year of Analysis: 2034  
Date of Analysis: 18-Jun-2021

INPUT	Value
85 <sup>th</sup> percentile speed, km/h:	100
Main Road A.A.D.T.	4,000
Minor (intersecting) Road A.A.D.T	4,000
Left turn volume ( $V_{LT}$ ), veh/h:	86
Advancing volume ( $V_{adv}$ ), veh/h:	146
Opposing volume ( $V_{opp}$ ), veh/h:	68
Left turn truck volume, trucks/h:	30
Right turn volume ( $V_{RT}$ ), veh/day:	568

OUTPUT	Value
Percent left-turns in advancing volume:	58.9%
Percent trucks in left turn volume:	34.9%
Probability of conflict threshold:	0.89%
Calculated probability of conflicting arrival:	0.4%
Calculated conflicts per hour, veh/h:	0.6

Use Detailed Method

Type II

RT Lane  
warranted

Additional Storage Not Required	base storage requirement		-
	- standard storage length		-
	+ additional truck storage		-
	= total additional storage required		-

### CALIBRATION CONSTANTS

Variable	Value
Average time for making left-turn, s:	3.0
Critical headway (gap), s:	5.0
Average time to clear, s:	1.9

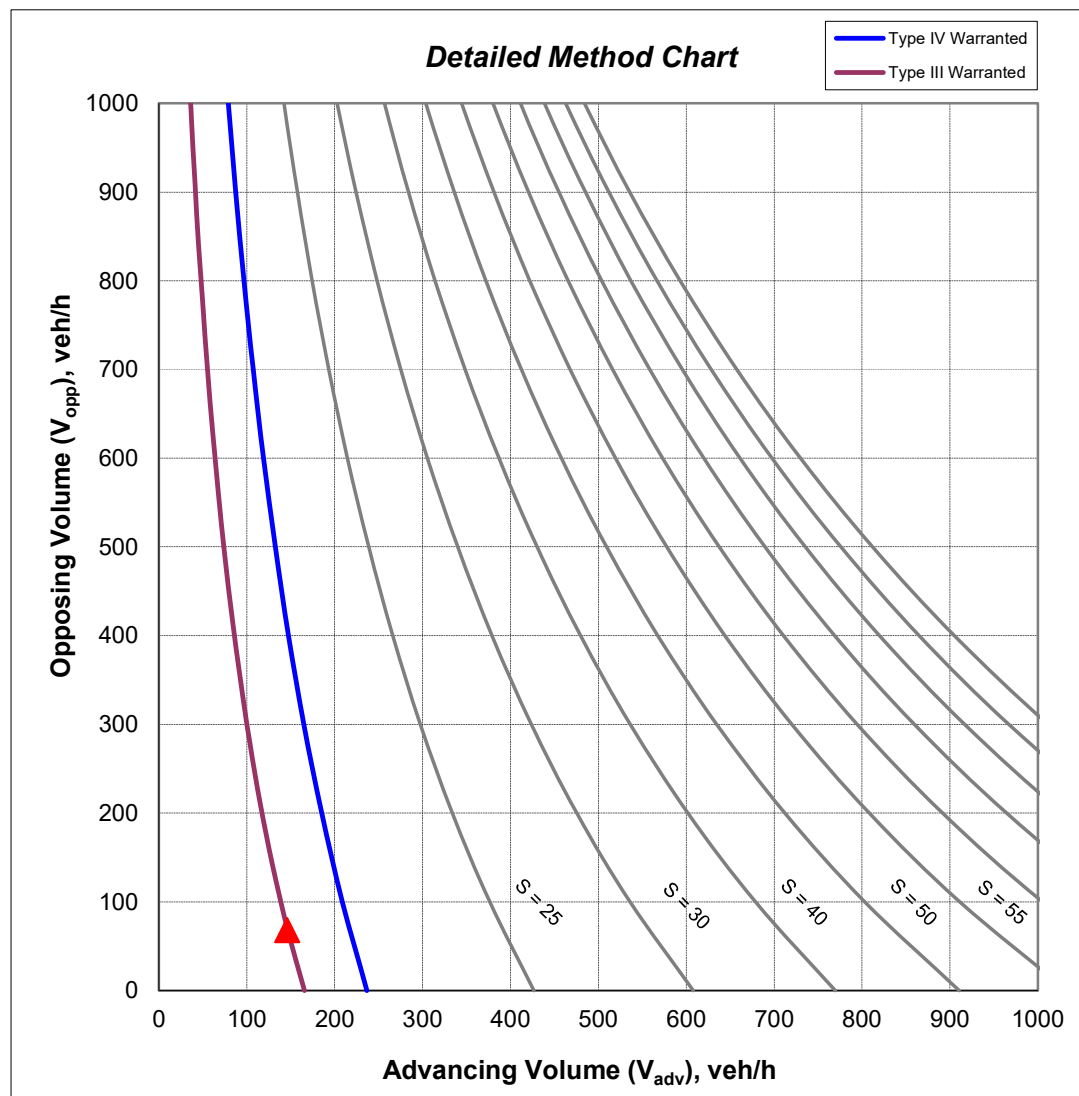



## Intersection Analysis Rural Two-Lane Undivided Highways

Main Rd: Highway 58  
Minor Rd: Highway 88

Direction: Eastbound  
Period: PM Peak

Year of Analysis: 2034  
Date of Analysis: 18-Jun-2021

INPUT	Value
85 <sup>th</sup> percentile speed, km/h:	100
Main Road A.A.D.T.	4,000
Minor (intersecting) Road A.A.D.T	4,000
Left turn volume ( $V_{LT}$ ), veh/h:	100
Advancing volume ( $V_{adv}$ ), veh/h:	184
Opposing volume ( $V_{opp}$ ), veh/h:	64
Left turn truck volume, trucks/h:	34
Right turn volume ( $V_{RT}$ ), veh/day:	568

OUTPUT	Value
Percent left-turns in advancing volume:	54.3%
Percent trucks in left turn volume:	34.0%
Probability of conflict threshold:	0.89%
Calculated probability of conflicting arrival:	0.7%
Calculated conflicts per hour, veh/h:	1.2

Use Detailed Method

Type III

RT Lane  
warranted

Additional Storage Not Required	base storage requirement		-
	- standard storage length		-
	+ additional truck storage		-
	= total additional storage required		-

### CALIBRATION CONSTANTS

Variable	Value
Average time for making left-turn, s:	3.0
Critical headway (gap), s:	5.0
Average time to clear, s:	1.9

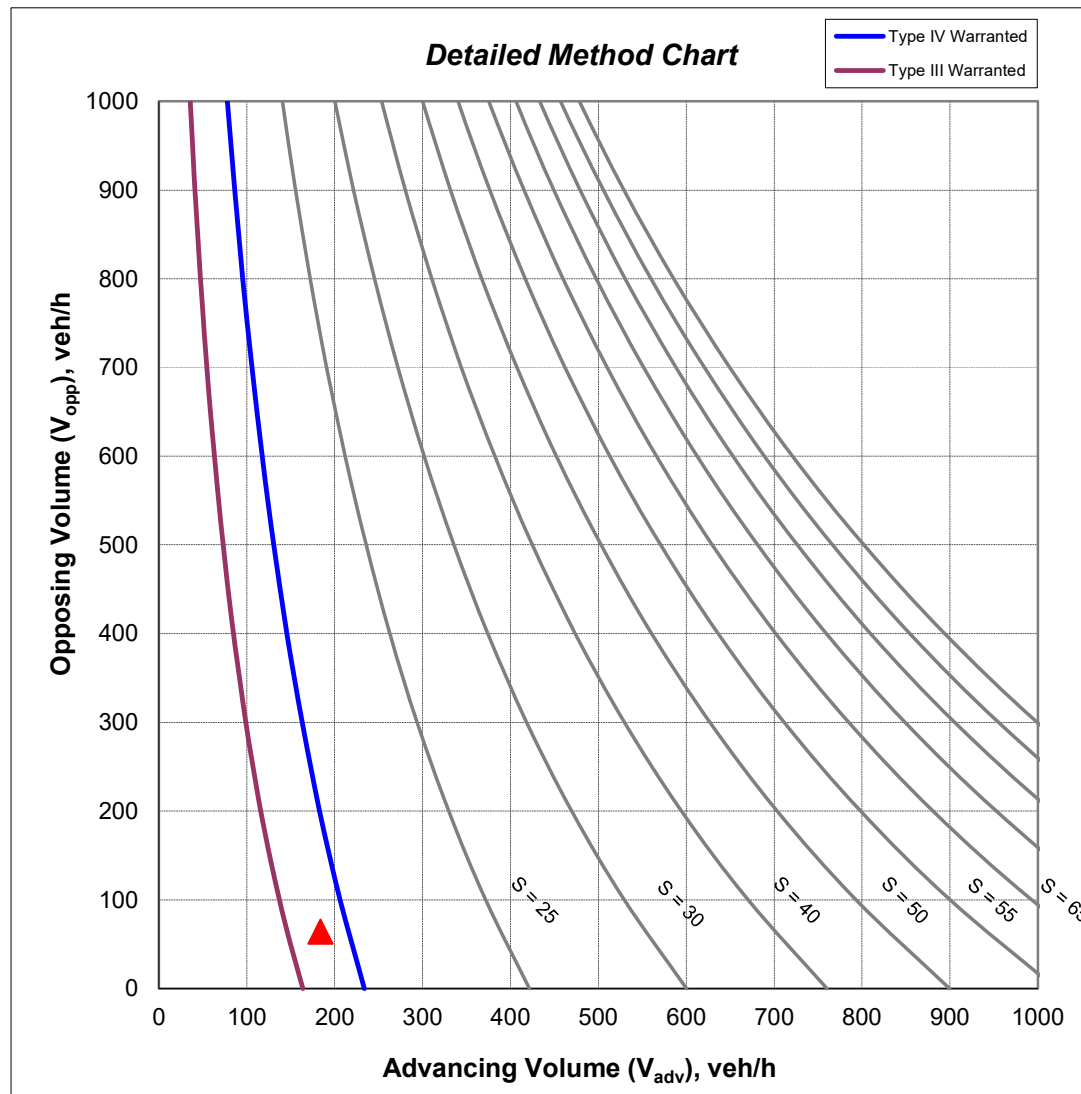



## Intersection Analysis Rural Two-Lane Undivided Highways

Main Rd: Highway 58  
Minor Rd: Highway 88

Direction: Westbound  
Period: AM Peak

Year of Analysis: 2024  
Date of Analysis: 18-Jun-2021

INPUT	Value
85 <sup>th</sup> percentile speed, km/h:	100
Main Road A.A.D.T.	4,000
Minor (intersecting) Road A.A.D.T	4,000
Left turn volume ( $V_{LT}$ ), veh/h:	6
Advancing volume ( $V_{adv}$ ), veh/h:	68
Opposing volume ( $V_{opp}$ ), veh/h:	146
Left turn truck volume, trucks/h:	2
Right turn volume ( $V_{RT}$ ), veh/day:	615

OUTPUT	Value
Percent left-turns in advancing volume:	8.8%
Percent trucks in left turn volume:	33.3%
Probability of conflict threshold:	0.89%
Calculated probability of conflicting arrival:	0.0%
Calculated conflicts per hour, veh/h:	0.0

Use Detailed Method

Type II

RT Lane  
warranted

Additional Storage Not Required	<i>base storage requirement</i>		-
	<i>- standard storage length</i>		-
	<i>+ additional truck storage</i>		-
	= total additional storage required		-

### CALIBRATION CONSTANTS

Variable	Value
Average time for making left-turn, s:	3.0
Critical headway (gap), s:	5.0
Average time to clear, s:	1.9

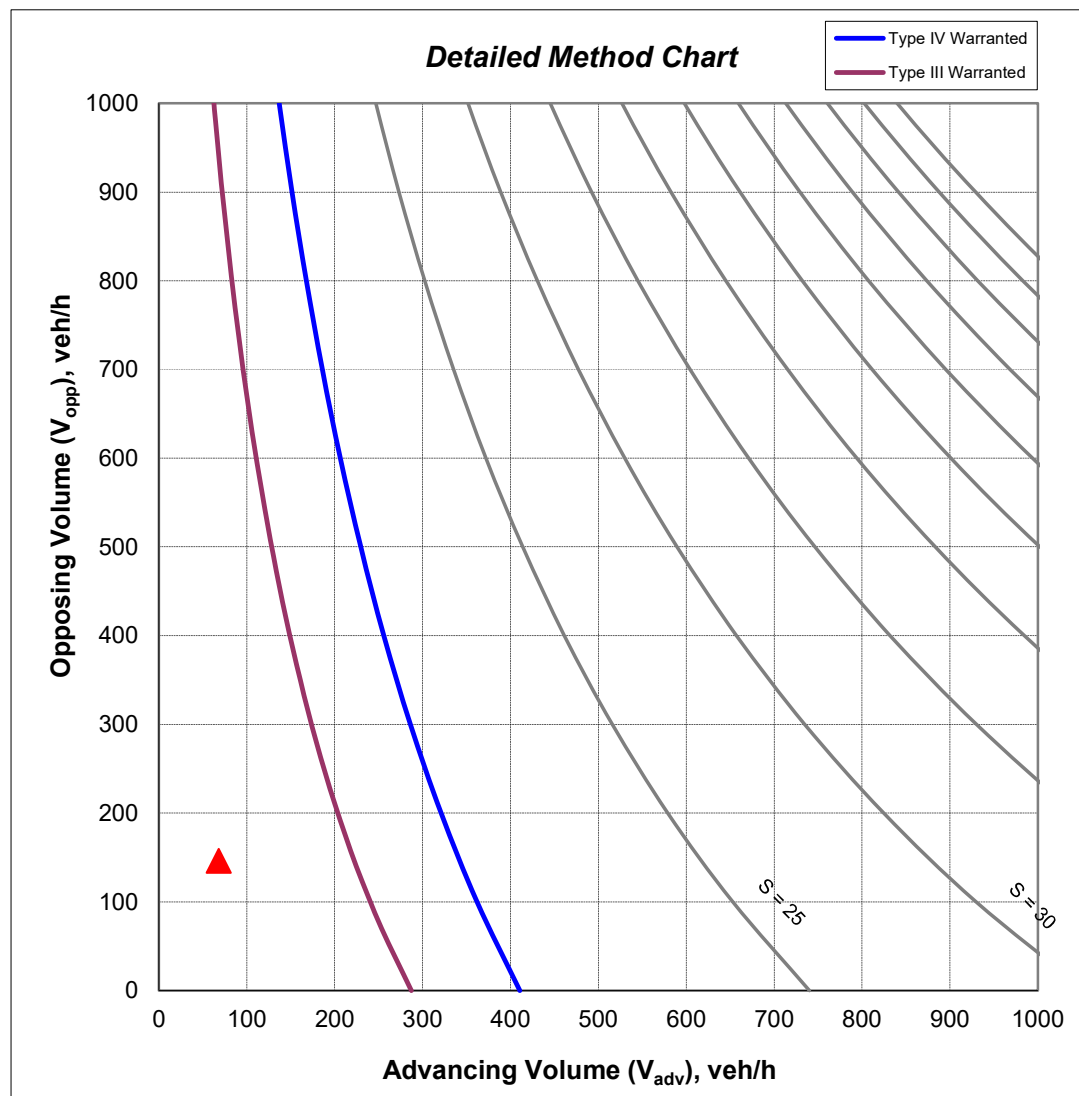





## Intersection Analysis Rural Two-Lane Undivided Highways

Main Rd: Highway 58  
Minor Rd: Highway 88

Direction: Westbound  
Period: PM Peak

Year of Analysis: 2034  
Date of Analysis: 18-Jun-2021

INPUT	Value
85 <sup>th</sup> percentile speed, km/h:	100
Main Road A.A.D.T.	4,000
Minor (intersecting) Road A.A.D.T	4,000
Left turn volume ( $V_{LT}$ ), veh/h:	8
Advancing volume ( $V_{adv}$ ), veh/h:	64
Opposing volume ( $V_{opp}$ ), veh/h:	184
Left turn truck volume, trucks/h:	3
Right turn volume ( $V_{RT}$ ), veh/day:	615

OUTPUT	Value
Percent left-turns in advancing volume:	12.5%
Percent trucks in left turn volume:	37.5%
Probability of conflict threshold:	0.89%
Calculated probability of conflicting arrival:	0.0%
Calculated conflicts per hour, veh/h:	0.0

Use Detailed Method

Type II

RT Lane  
warranted

Additional Storage Not Required	base storage requirement		-
	- standard storage length		-
	+ additional truck storage		-
	= total additional storage required		-

### CALIBRATION CONSTANTS

Variable	Value
Average time for making left-turn, s:	3.0
Critical headway (gap), s:	5.0
Average time to clear, s:	1.9

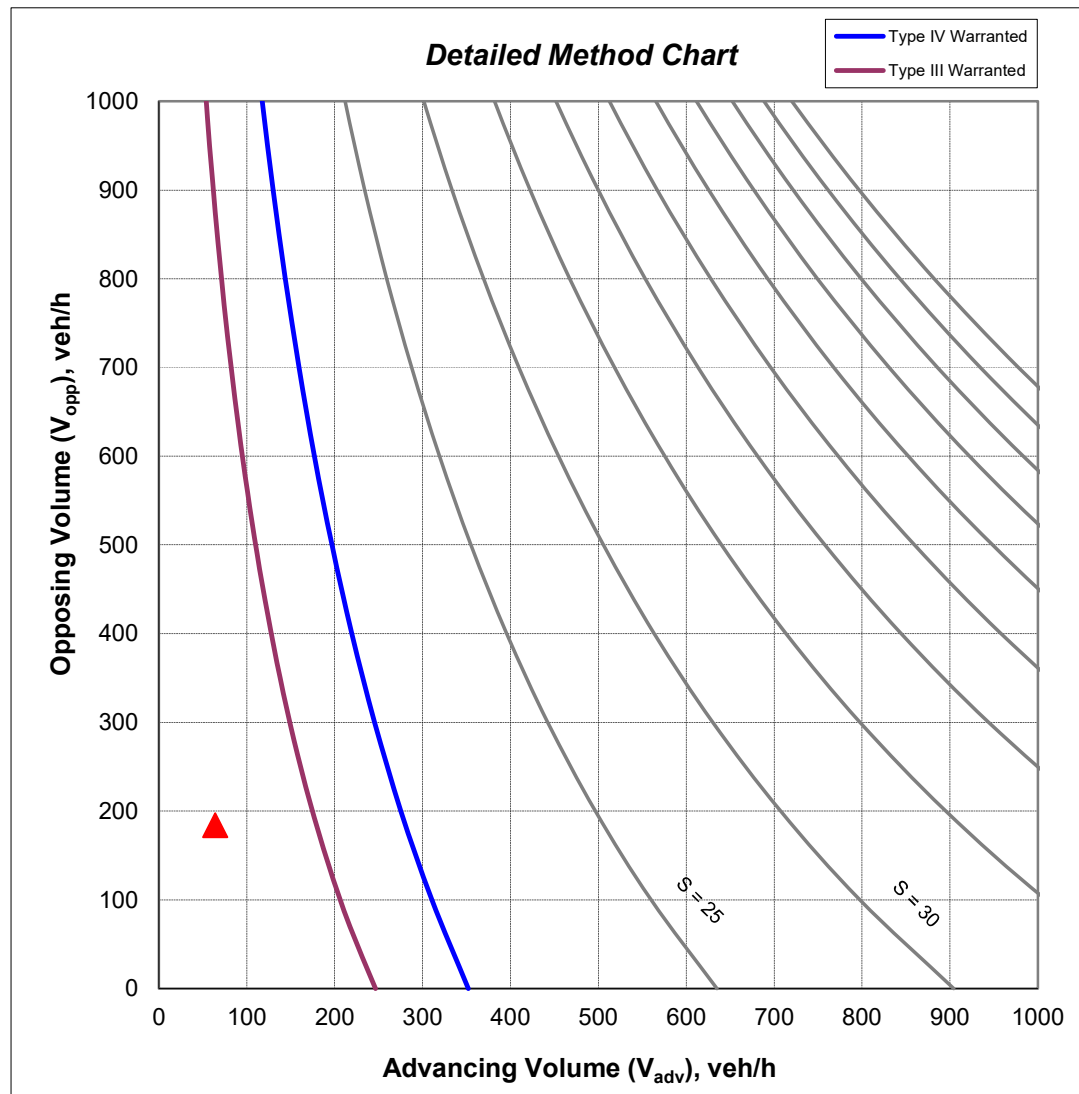



## Intersection Analysis Rural Two-Lane Undivided Highways

Main Rd: Highway 58  
Minor Rd: Highway 88

Direction: Eastbound  
Period: AM Peak

Year of Analysis: 2044  
Date of Analysis: 18-Jun-2021

INPUT	Value
85 <sup>th</sup> percentile speed, km/h:	100
Main Road A.A.D.T.	5,000
Minor (intersecting) Road A.A.D.T	5,000
Left turn volume ( $V_{LT}$ ), veh/h:	132
Advancing volume ( $V_{adv}$ ), veh/h:	213
Opposing volume ( $V_{opp}$ ), veh/h:	95
Left turn truck volume, trucks/h:	40
Right turn volume ( $V_{RT}$ ), veh/day:	829

OUTPUT	Value
Percent left-turns in advancing volume:	62.0%
Percent trucks in left turn volume:	30.3%
Probability of conflict threshold:	0.89%
Calculated probability of conflicting arrival:	0.9%
Calculated conflicts per hour, veh/h:	1.9

Use Detailed Method

Type IV

RT Lane  
warranted

Additional Storage Not Required	base storage requirement		-
	- standard storage length		-
	+ additional truck storage		-
	= total additional storage required		-

### CALIBRATION CONSTANTS

Variable	Value
Average time for making left-turn, s:	3.0
Critical headway (gap), s:	5.0
Average time to clear, s:	1.9

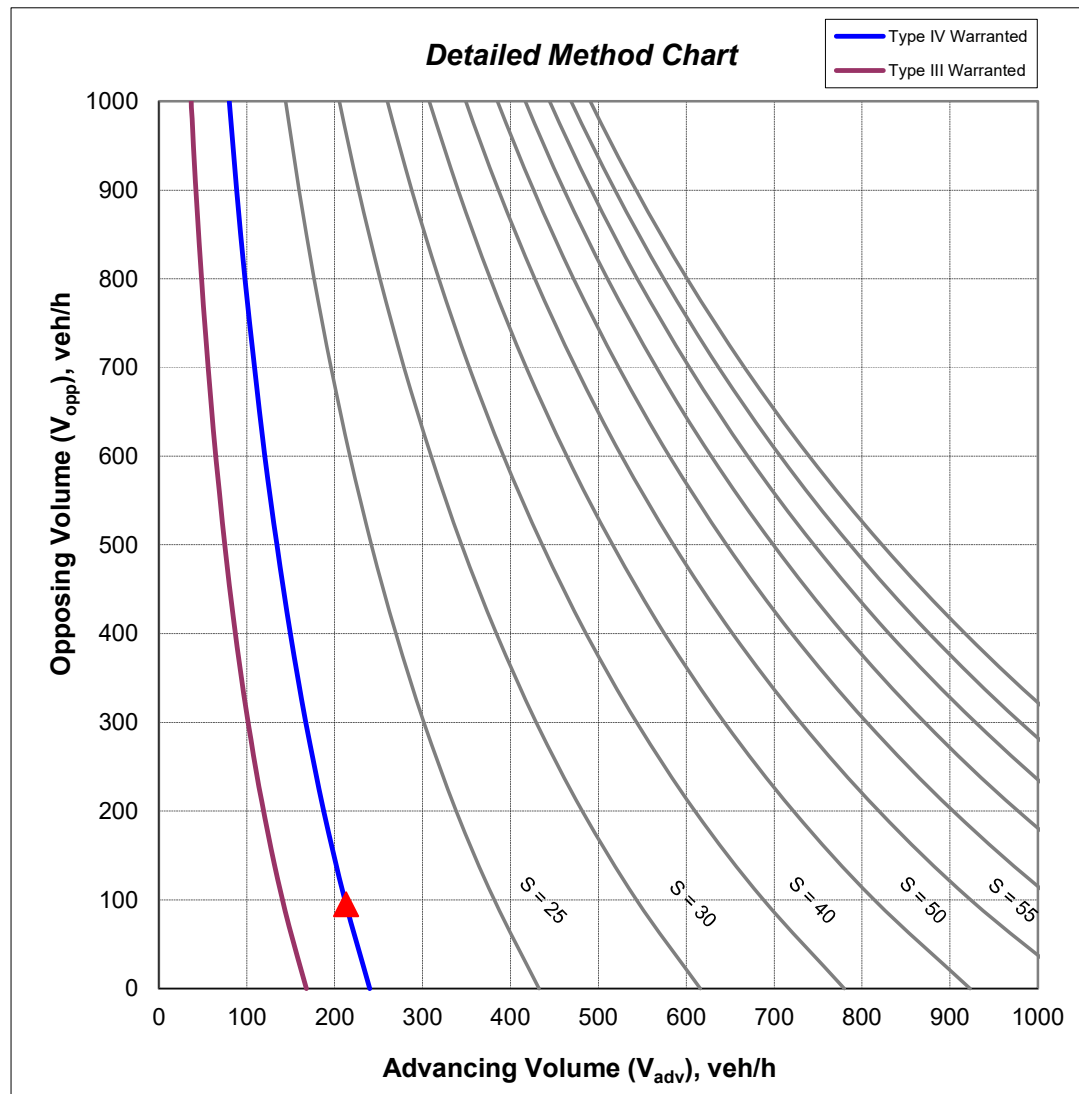



## Intersection Analysis Rural Two-Lane Undivided Highways

Main Rd: Highway 58  
Minor Rd: Highway 88

Direction: Eastbound  
Period: PM Peak

Year of Analysis: 2044  
Date of Analysis: 18-Jun-2021

INPUT	Value
85 <sup>th</sup> percentile speed, km/h:	100
Main Road A.A.D.T.	5,000
Minor (intersecting) Road A.A.D.T	5,000
Left turn volume ( $V_{LT}$ ), veh/h:	106
Advancing volume ( $V_{adv}$ ), veh/h:	204
Opposing volume ( $V_{opp}$ ), veh/h:	69
Left turn truck volume, trucks/h:	35
Right turn volume ( $V_{RT}$ ), veh/day:	829

OUTPUT	Value
Percent left-turns in advancing volume:	52.0%
Percent trucks in left turn volume:	33.0%
Probability of conflict threshold:	0.89%
Calculated probability of conflicting arrival:	0.8%
Calculated conflicts per hour, veh/h:	1.7

Use Detailed Method

Type III

RT Lane  
warranted

Additional Storage Not Required	base storage requirement		-
	- standard storage length		-
	+ additional truck storage		-
	= total additional storage required		-

### CALIBRATION CONSTANTS

Variable	Value
Average time for making left-turn, s:	3.0
Critical headway (gap), s:	5.0
Average time to clear, s:	1.9

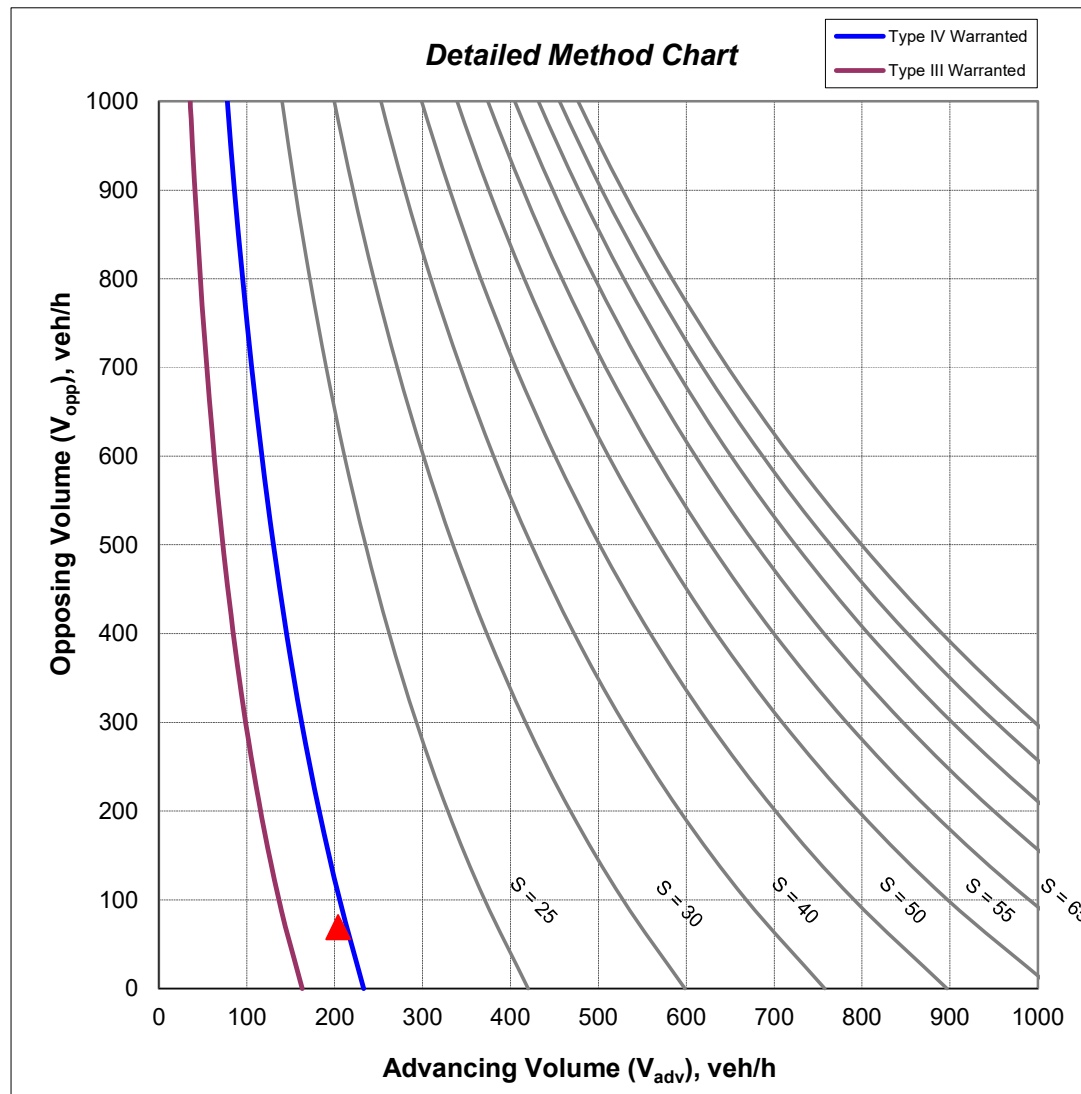



## Intersection Analysis Rural Two-Lane Undivided Highways

Main Rd: Highway 58  
Minor Rd: Highway 88

Direction: Westbound  
Period: AM Peak

Year of Analysis: 2044  
Date of Analysis: 18-Jun-2021

INPUT	Value
85 <sup>th</sup> percentile speed, km/h:	100
Main Road A.A.D.T.	5,000
Minor (intersecting) Road A.A.D.T	5,000
Left turn volume ( $V_{LT}$ ), veh/h:	7
Advancing volume ( $V_{adv}$ ), veh/h:	95
Opposing volume ( $V_{opp}$ ), veh/h:	213
Left turn truck volume, trucks/h:	3
Right turn volume ( $V_{RT}$ ), veh/day:	721

OUTPUT	Value
Percent left-turns in advancing volume:	7.4%
Percent trucks in left turn volume:	42.9%
Probability of conflict threshold:	0.89%
Calculated probability of conflicting arrival:	0.1%
Calculated conflicts per hour, veh/h:	0.1

Use Detailed Method

Type II

RT Lane  
warranted

Additional Storage Not Required	<i>base storage requirement</i>		-
	<i>- standard storage length</i>		-
	<i>+ additional truck storage</i>		-
	= total additional storage required		-

### CALIBRATION CONSTANTS

Variable	Value
Average time for making left-turn, s:	3.0
Critical headway (gap), s:	5.0
Average time to clear, s:	1.9

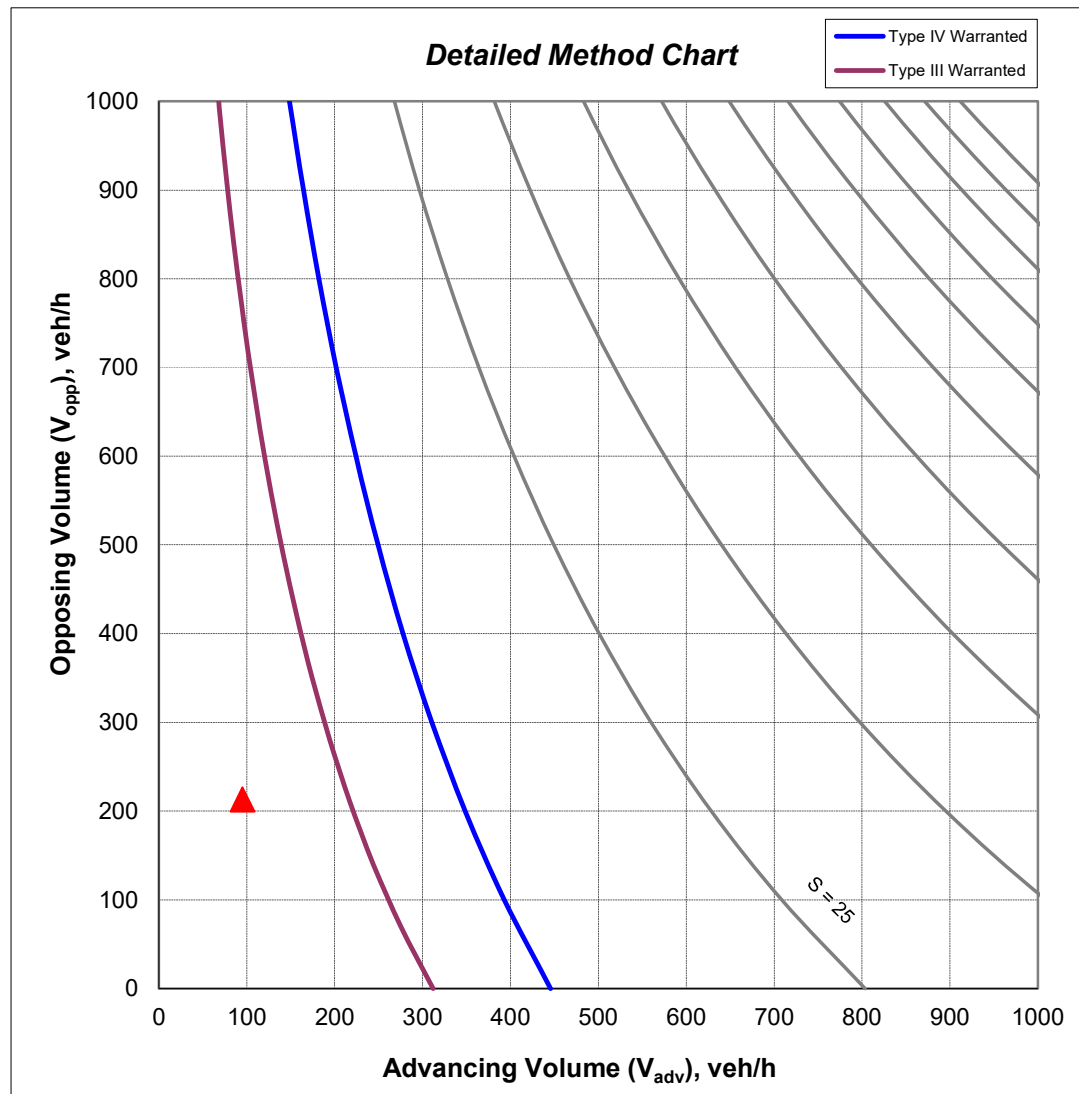



## Intersection Analysis Rural Two-Lane Undivided Highways

Main Rd: Highway 58  
Minor Rd: Highway 88

Direction: Westbound  
Period: PM Peak

Year of Analysis: 2044  
Date of Analysis: 18-Jun-2021

INPUT	Value
85 <sup>th</sup> percentile speed, km/h:	100
Main Road A.A.D.T.	5,000
Minor (intersecting) Road A.A.D.T	5,000
Left turn volume ( $V_{LT}$ ), veh/h:	9
Advancing volume ( $V_{adv}$ ), veh/h:	69
Opposing volume ( $V_{opp}$ ), veh/h:	204
Left turn truck volume, trucks/h:	3
Right turn volume ( $V_{RT}$ ), veh/day:	721

OUTPUT	Value
Percent left-turns in advancing volume:	13.0%
Percent trucks in left turn volume:	33.3%
Probability of conflict threshold:	0.89%
Calculated probability of conflicting arrival:	0.1%
Calculated conflicts per hour, veh/h:	0.0

Use Detailed Method

Type II

RT Lane  
warranted

Additional Storage Not Required	base storage requirement		-
	- standard storage length	-	-
	+ additional truck storage	-	-
= total additional storage required			-

### CALIBRATION CONSTANTS

Variable	Value
Average time for making left-turn, s:	3.0
Critical headway (gap), s:	5.0
Average time to clear, s:	1.9

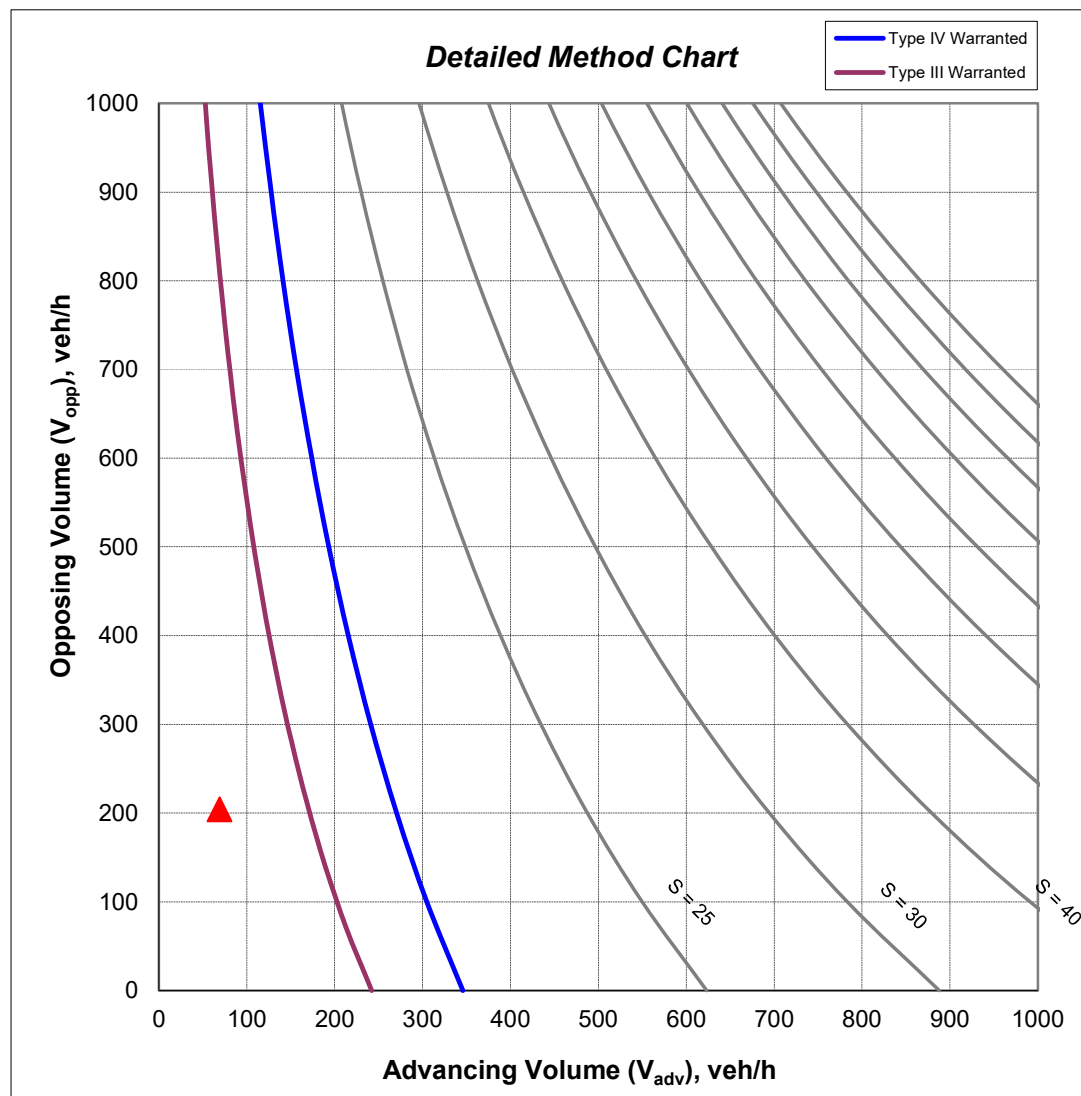



## Intersection Analysis Rural Two-Lane Undivided Highways

Main Rd: Highway 58  
Minor Rd: East Access

Direction: Eastbound  
Period: AM Peak

Year of Analysis: 2044  
Date of Analysis: 18-Jun-2021

INPUT	Value
85 <sup>th</sup> percentile speed, km/h:	100
Main Road A.A.D.T.	2,000
Minor (intersecting) Road A.A.D.T	300
Left turn volume ( $V_{LT}$ ), veh/h:	23
Advancing volume ( $V_{adv}$ ), veh/h:	72
Opposing volume ( $V_{opp}$ ), veh/h:	101
Left turn truck volume, trucks/h:	8
Right turn volume ( $V_{RT}$ ), veh/day:	27

OUTPUT	Value
Percent left-turns in advancing volume:	31.9%
Percent trucks in left turn volume:	34.8%
Probability of conflict threshold:	0.89%
Calculated probability of conflicting arrival:	0.1%
Calculated conflicts per hour, veh/h:	0.1

Use Detailed Method

Type II

Additional Storage Not Required	base storage requirement	-
	- standard storage length	-
	+ additional truck storage	-
	= total additional storage required	-

### CALIBRATION CONSTANTS

Variable	Value
Average time for making left-turn, s:	3.0
Critical headway (gap), s:	5.0
Average time to clear, s:	1.9

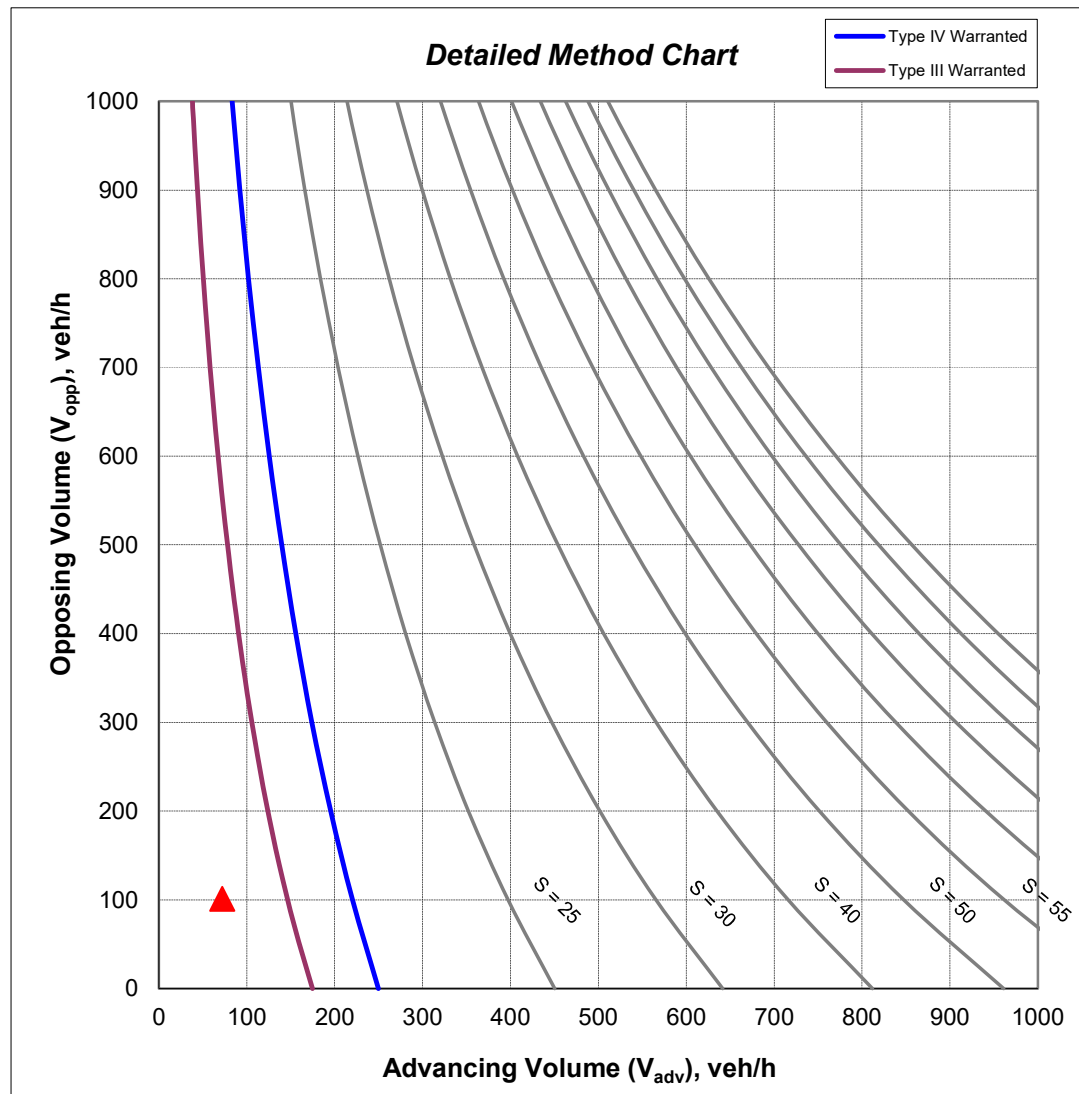



## Intersection Analysis Rural Two-Lane Undivided Highways

Main Rd: Highway 58  
Minor Rd: East Access

Direction: Eastbound  
Period: PM Peak

Year of Analysis: 2044  
Date of Analysis: 18-Jun-2021

INPUT	Value
85 <sup>th</sup> percentile speed, km/h:	100
Main Road A.A.D.T.	2,000
Minor (intersecting) Road A.A.D.T	300
Left turn volume ( $V_{LT}$ ), veh/h:	3
Advancing volume ( $V_{adv}$ ), veh/h:	103
Opposing volume ( $V_{opp}$ ), veh/h:	66
Left turn truck volume, trucks/h:	1
Right turn volume ( $V_{RT}$ ), veh/day:	27

OUTPUT	Value
Percent left-turns in advancing volume:	2.9%
Percent trucks in left turn volume:	33.3%
Probability of conflict threshold:	0.89%
Calculated probability of conflicting arrival:	0.0%
Calculated conflicts per hour, veh/h:	0.0

**Use Detailed Method**

**Type II**

<b>Additional Storage Not Required</b>	<i>base storage requirement</i>	-
	<i>- standard storage length</i>	-
	<i>+ additional truck storage</i>	-
	= total additional storage required	-

### CALIBRATION CONSTANTS

Variable	Value
Average time for making left-turn, s:	3.0
Critical headway (gap), s:	5.0
Average time to clear, s:	1.9

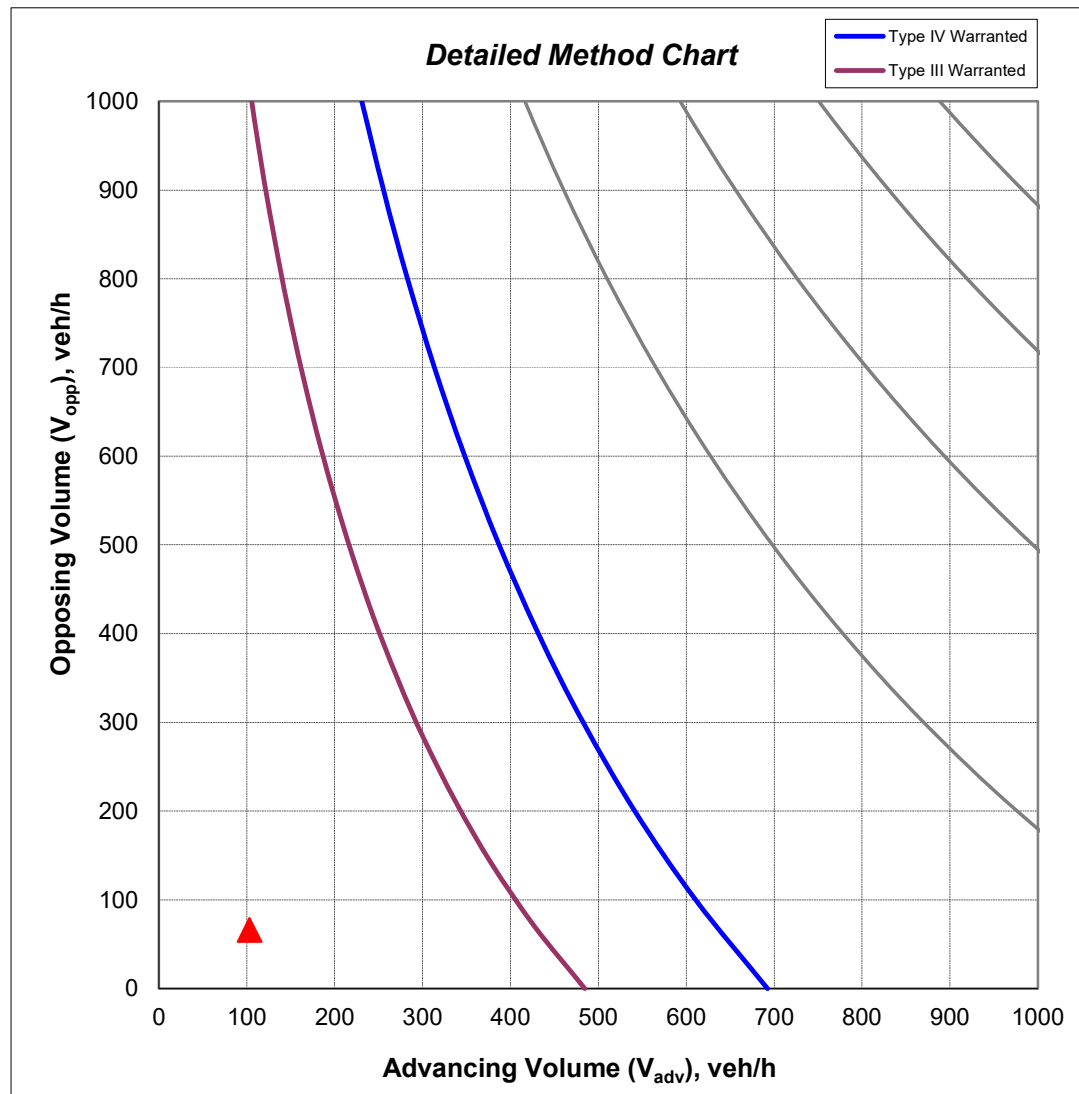

# APPENDIX D:

# INTERSECTION DESIGN AND TREATMENT



NOTES: DIMENSIONS SHOWN ARE FINISHED SURFACE PAVEMENT WIDTHS.  
 ADDITIONAL SUBGRADE WIDTHS TO BE PROVIDED TO ALLOW  
 FOR DEPTH OF BASE COURSE AND PAVEMENT.

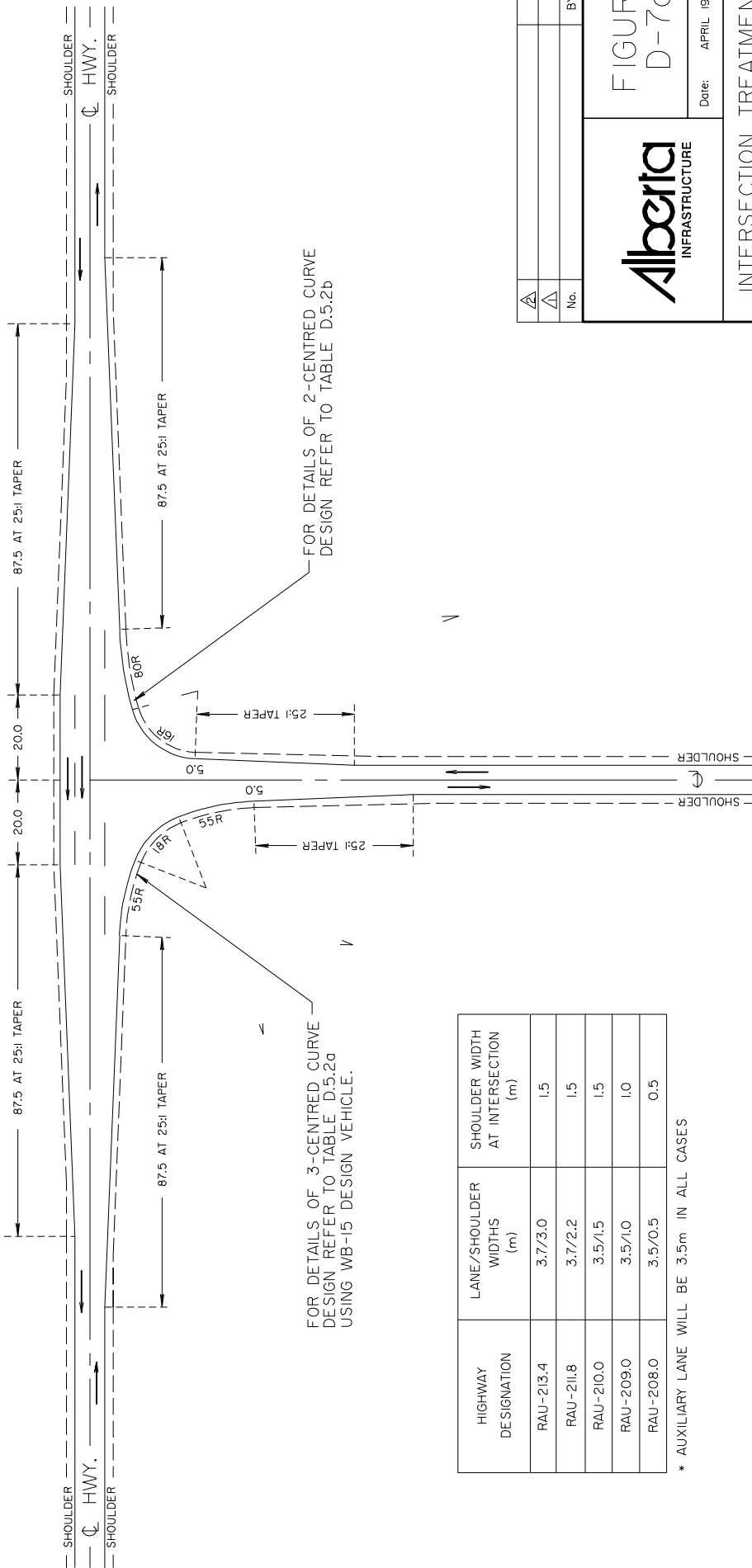

FOR DETAILS OF 3-CENTRED CURVE  
 DESIGN REFER TO TABLE D.5.2a  
 USING WB-15 DESIGN VEHICLE.

FOR DETAILS OF 2-CENTRED CURVE  
 DESIGN REFER TO TABLE D.5.2b

HIGHWAY DESIGNATION	LANE/SHOULDER WIDTHS (m)	SHOULDER WIDTH AT INTERSECTION (m)
RAU-213.4	3.7/3.0	1.5
RAU-211.8	3.7/2.2	1.5
RAU-210.0	3.5/1.5	1.5
RAU-209.0	3.5/1.0	1.0
RAU-208.0	3.5/0.5	0.5

\* AUXILIARY LANE WILL BE 3.5m IN ALL CASES

△			
△			
No.		BY	DATE

**Alberta**  
 INFRASTRUCTURE

FIGURE D-7c

Date: APRIL 1995

INTERSECTION TREATMENT  
 (TYPE IIa)  
 (TWO-LANE HIGHWAY)

Prepared By: R.T.	Checked By: B.K.	Scale: N.T.S.	PAGE D-117
-------------------	------------------	---------------	------------

TABLE 2: LEFT TURN LANE

HIGHWAY DESIGN SPEED km/h	LENGTH AND TAPER RATIO 1/2 OF BYPASS LANE (m)	PARALLEL DECELERATION LANE "P2" ** (m)	LENGTH AVAILABLE FOR DECELERATION 1/2 TAPER+LANE (m)	DECELERATION LENGTH REQUIRED BASED ON DESIGN SPEED	STORAGE LENGTH PROVIDED BY STANDARD TREATMENT
50	140 or 40:1	20	90	70	20
60	140 or 40:1	35	105	90	15
70	140 or 40:1	55	125	110	15
80	140 or 40:1	80	150	130	20
90	210 or 60:1	70	175	150	25
100	210 or 60:1	85	190	170	20
110	210 or 60:1	100	210	190	20
120	210 or 60:1	120	235	210	15
130	210 or 60:1	125	230	215	15

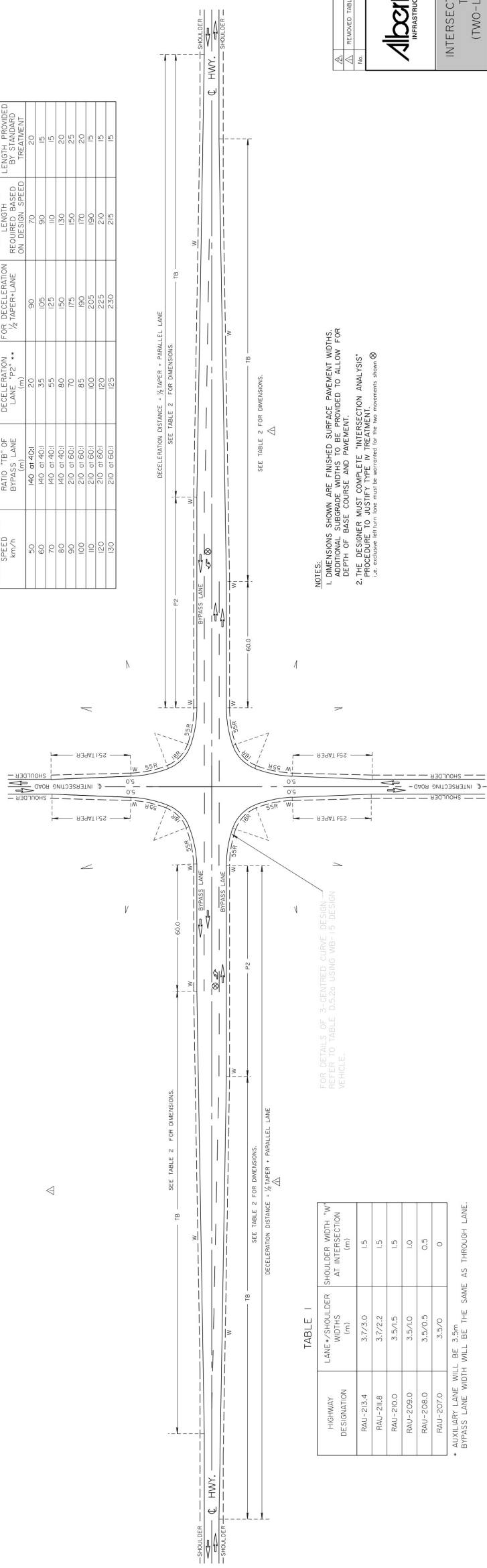

TABLE 1

HIGHWAY DESIGNATION	LANE+SHOULDER WIDTHS (m)	SHOULDER WIDTH AT INTERSECTION (m)
RAU-213.4	3.7/3.0	1.5
RAU-211.8	3.7/2.2	1.5
RAU-210.0	3.5/1.5	1.5
RAU-209.0	3.5/1.0	1.0
RAU-208.0	3.5/0.5	0.5
RAU-207.0	3.5/0	0

\* AUXILIARY LANE WIDTH BE 3.5m  
 BYPASS LANE WIDTH WILL BE THE SAME AS THROUGH LANE.

FOR DETAILS OF 3-CENTRED CURVE DESIGN REFER TO TABLE D.5.2a USING WB-1.5 DESIGN VEHICLE.

- NOTES:
1. DIMENSIONS SHOWN ARE FINISHED SURFACE PAVEMENT WIDTHS. DIMENSIONS SHOWN IN PARENTHESES ARE PROVIDED TO ALLOW FOR DEPTH OF BASE COURSE AND PAVEMENT.
  2. THE DESIGNER MUST COMPLETE "INTERSECTION ANALYSIS" PROCEDURE TO JUSTIFY TYPE IV TREATMENT. i.e. exclusive left turn lane must be warranted for the two movements shown ☒

DECELERATION DISTANCE = 1/2 TAPER + PARALLEL LANE  
 SEE TABLE 2 FOR DIMENSIONS.

DECELERATION DISTANCE = 1/2 TAPER + PARALLEL LANE  
 SEE TABLE 2 FOR DIMENSIONS.

	REMOVED TABLE 3: REV. TAPER NOTE	BK	B-29
		BT	DATE
		Date: OCTOBER 1994	
INTERSECTION TREATMENT TYPE IVc (TWO-LANE HIGHWAY)		Scale: N.T.S.	PAGE: D-135
Prepared By: GPK	Checked By: [ ]		

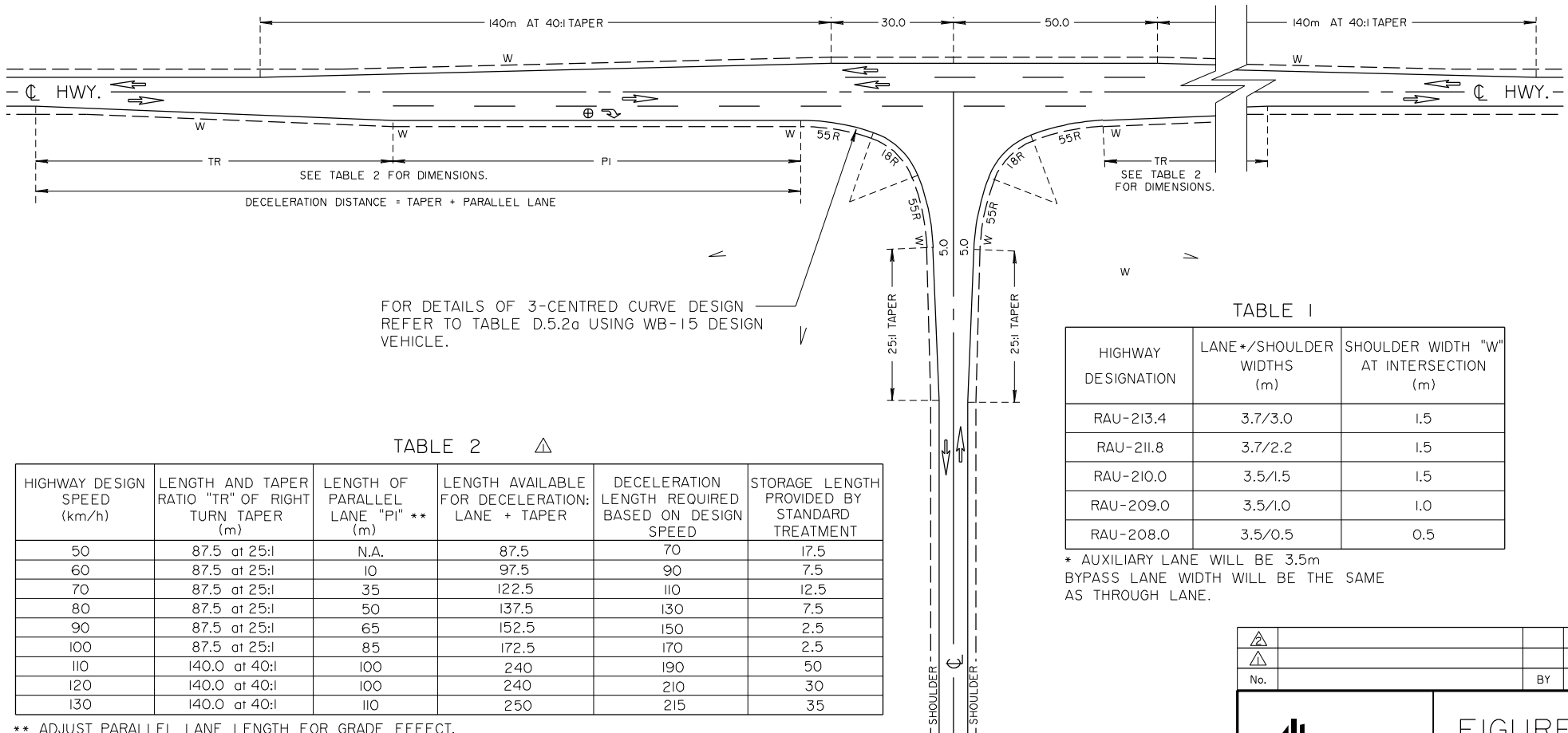

FOR DETAILS OF 3-CENTRED CURVE DESIGN REFER TO TABLE D.5.2a USING WB-15 DESIGN VEHICLE.

TABLE 2  $\Delta$

HIGHWAY DESIGN SPEED (km/h)	LENGTH AND TAPER RATIO "TR" OF RIGHT TURN TAPER (m)	LENGTH OF PARALLEL LANE "PI" ** (m)	LENGTH AVAILABLE FOR DECELERATION: LANE + TAPER	DECELERATION LENGTH REQUIRED BASED ON DESIGN SPEED	STORAGE LENGTH PROVIDED BY STANDARD TREATMENT
50	87.5 at 25:1	N.A.	87.5	70	17.5
60	87.5 at 25:1	10	97.5	90	7.5
70	87.5 at 25:1	35	122.5	110	12.5
80	87.5 at 25:1	50	137.5	130	7.5
90	87.5 at 25:1	65	152.5	150	2.5
100	87.5 at 25:1	85	172.5	170	2.5
110	140.0 at 40:1	100	240	190	50
120	140.0 at 40:1	100	240	210	30
130	140.0 at 40:1	110	250	215	35

\*\* ADJUST PARALLEL LANE LENGTH FOR GRADE EFFECT.

NOTES

- DIMENSIONS SHOWN ARE FINISHED SURFACE PAVEMENT WIDTHS. ADDITIONAL SUBGRADE WIDTHS TO BE PROVIDED TO ALLOW FOR DEPTH OF BASE COURSE AND PAVEMENT.
- THE DESIGNER MUST COMPLETE "INTERSECTION ANALYSIS" PROCEDURE TO JUSTIFY THE TYPE IV TREATMENT. i.e. exclusive right turn lane must be warranted for the movement shown  $\oplus$

TABLE 1

HIGHWAY DESIGNATION	LANE*/SHOULDER WIDTHS (m)	SHOULDER WIDTH "W" AT INTERSECTION (m)
RAU-213.4	3.7/3.0	1.5
RAU-211.8	3.7/2.2	1.5
RAU-210.0	3.5/1.5	1.5
RAU-209.0	3.5/1.0	1.0
RAU-208.0	3.5/0.5	0.5

\* AUXILIARY LANE WILL BE 3.5m  
BYPASS LANE WIDTH WILL BE THE SAME AS THROUGH LANE.

$\Delta$			
$\Delta$			
No.		BY	DATE



FIGURE D-7m

Date: APRIL 1995

INTERSECTION TREATMENT  
TYPE IVd  
EXCLUSIVE RIGHT TURN TREATMENT  
WARRANTED (TWO-LANE HIGHWAY)



















Prepared By: Cgk	Checked By: B.K.	Scale: N.T.S.	PAGE D-137
------------------	------------------	---------------	------------

# APPENDIX E:

# SYNCHRO OUTPUT FILES









HCM Unsignalized Intersection Capacity Analysis  
 3: Highway 88/Range Road 135 & Highway 58

2024 AM Peak - Background Traffic  
 07/20/2021

												
Movement	EBL	EBT	EBR	WBL	WBT	WBR	NBL	NBT	NBR	SBL	SBT	SBR
Lane Configurations												
Traffic Volume (veh/h)	8	5	45	5	16	4	67	8	4	2	3	3
Future Volume (Veh/h)	8	5	45	5	16	4	67	8	4	2	3	3
Sign Control		Free			Free			Stop			Stop	
Grade		0%			0%			0%			0%	
Peak Hour Factor	0.92	0.92	0.92	0.92	0.92	0.92	0.92	0.92	0.92	0.92	0.92	0.92
Hourly flow rate (vph)	9	5	49	5	17	4	73	9	4	2	3	3
Pedestrians												
Lane Width (m)												
Walking Speed (m/s)												
Percent Blockage												
Right turn flare (veh)												
Median type		None			None							
Median storage (veh)												
Upstream signal (m)												
pX, platoon unblocked												
vC, conflicting volume	21			54			79	78	30	60	101	19
vC1, stage 1 conf vol												
vC2, stage 2 conf vol												
vCu, unblocked vol	21			54			79	78	30	60	101	19
tC, single (s)	4.4			4.4			7.4	6.8	6.5	7.4	6.8	6.5
tC, 2 stage (s)												
tF (s)	2.5			2.5			3.8	4.3	3.6	3.8	4.3	3.6
p0 queue free %	99			100			91	99	100	100	100	100
cM capacity (veh/h)	1431			1390			834	754	970	852	732	984
Direction, Lane #	EB 1	EB 2	WB 1	WB 2	NB 1	SB 1						
Volume Total	9	54	5	21	86	8						
Volume Left	9	0	5	0	73	2						
Volume Right	0	49	0	4	4	3						
cSH	1431	1700	1390	1700	830	843						
Volume to Capacity	0.01	0.03	0.00	0.01	0.10	0.01						
Queue Length 95th (m)	0.1	0.0	0.1	0.0	2.6	0.2						
Control Delay (s)	7.5	0.0	7.6	0.0	9.8	9.3						
Lane LOS	A		A		A	A						
Approach Delay (s)	1.1		1.5		9.8	9.3						
Approach LOS					A	A						
Intersection Summary												
Average Delay			5.6									
Intersection Capacity Utilization			25.0%		ICU Level of Service				A			
Analysis Period (min)			15									

HCM Unsignalized Intersection Capacity Analysis  
4: Range Road 135 & Phase 1 Access



















2024 AM Peak - Background Traffic  
07/20/2021

						
Movement	WBL	WBR	NBT	NBR	SBL	SBT
Lane Configurations						
Traffic Volume (veh/h)	9	0	0	19	0	0
Future Volume (Veh/h)	9	0	0	19	0	0
Sign Control	Stop		Free			Free
Grade	0%		0%			0%
Peak Hour Factor	0.92	0.92	0.92	0.92	0.92	0.92
Hourly flow rate (vph)	10	0	0	21	0	0
Pedestrians						
Lane Width (m)						
Walking Speed (m/s)						
Percent Blockage						
Right turn flare (veh)						
Median type			None			None
Median storage veh						
Upstream signal (m)						
pX, platoon unblocked						
vC, conflicting volume	10	10			21	
vC1, stage 1 conf vol						
vC2, stage 2 conf vol						
vCu, unblocked vol	10	10			21	
tC, single (s)	6.7	6.5			4.4	
tC, 2 stage (s)						
tF (s)	3.8	3.6			2.5	
p0 queue free %	99	100			100	
cM capacity (veh/h)	942	995			1431	
Direction, Lane #	WB 1	NB 1	SB 1			
Volume Total	10	21	0			
Volume Left	10	0	0			
Volume Right	0	21	0			
cSH	942	1700	1700			
Volume to Capacity	0.01	0.01	0.00			
Queue Length 95th (m)	0.2	0.0	0.0			
Control Delay (s)	8.9	0.0	0.0			
Lane LOS	A					
Approach Delay (s)	8.9	0.0	0.0			
Approach LOS	A					
Intersection Summary						
Average Delay			2.9			
Intersection Capacity Utilization		13.3%		ICU Level of Service		A
Analysis Period (min)			15			

HCM Unsignalized Intersection Capacity Analysis  
 3: Highway 88/Range Road 135 & Highway 58

2024 PM Peak - Background Traffic

07/20/2021

												
Movement	EBL	EBT	EBR	WBL	WBT	WBR	NBL	NBT	NBR	SBL	SBT	SBR
Lane Configurations												
Traffic Volume (veh/h)	5	10	60	6	5	3	56	6	13	4	9	9
Future Volume (Veh/h)	5	10	60	6	5	3	56	6	13	4	9	9
Sign Control		Free			Free			Stop			Stop	
Grade		0%			0%			0%			0%	
Peak Hour Factor	0.92	0.92	0.92	0.92	0.92	0.92	0.92	0.92	0.92	0.92	0.92	0.92
Hourly flow rate (vph)	5	11	65	7	5	3	61	7	14	4	10	10
Pedestrians												
Lane Width (m)												
Walking Speed (m/s)												
Percent Blockage												
Right turn flare (veh)												
Median type		None			None							
Median storage (veh)												
Upstream signal (m)												
pX, platoon unblocked												
vC, conflicting volume	8			76			88	76	44	59	106	6
vC1, stage 1 conf vol												
vC2, stage 2 conf vol												
vCu, unblocked vol	8			76			88	76	44	59	106	6
tC, single (s)	4.4			4.4			7.4	6.8	6.5	7.4	6.8	6.5
tC, 2 stage (s)												
tF (s)	2.5			2.5			3.8	4.3	3.6	3.8	4.3	3.6
p0 queue free %	100			99			92	99	99	100	99	99
cM capacity (veh/h)	1447			1363			812	758	952	848	728	1000
Direction, Lane #	EB 1	EB 2	WB 1	WB 2	NB 1	SB 1						
Volume Total	5	76	7	8	82	24						
Volume Left	5	0	7	0	61	4						
Volume Right	0	65	0	3	14	10						
cSH	1447	1700	1363	1700	828	843						
Volume to Capacity	0.00	0.04	0.01	0.00	0.10	0.03						
Queue Length 95th (m)	0.1	0.0	0.1	0.0	2.5	0.7						
Control Delay (s)	7.5	0.0	7.7	0.0	9.8	9.4						
Lane LOS	A		A		A	A						
Approach Delay (s)	0.5		3.6		9.8	9.4						
Approach LOS					A	A						
Intersection Summary												
Average Delay			5.6									
Intersection Capacity Utilization			23.0%		ICU Level of Service		A					
Analysis Period (min)			15									

HCM Unsignalized Intersection Capacity Analysis  
4: Range Road 135 & Phase 1 Access

2024 PM Peak - Background Traffic  
07/20/2021





















Movement	WBL	WBR	NBT	NBR	SBL	SBT
Lane Configurations						
Traffic Volume (veh/h)	22	0	0	13	0	0
Future Volume (Veh/h)	22	0	0	13	0	0
Sign Control	Stop		Free			Free
Grade	0%		0%			0%
Peak Hour Factor	0.92	0.92	0.92	0.92	0.92	0.92
Hourly flow rate (vph)	24	0	0	14	0	0
Pedestrians						
Lane Width (m)						
Walking Speed (m/s)						
Percent Blockage						
Right turn flare (veh)						
Median type			None	None		
Median storage veh						
Upstream signal (m)						
pX, platoon unblocked						
vC, conflicting volume	7	7			14	
vC1, stage 1 conf vol						
vC2, stage 2 conf vol						
vCu, unblocked vol	7	7			14	
tC, single (s)	6.7	6.5			4.4	
tC, 2 stage (s)						
tF (s)	3.8	3.6			2.5	
p0 queue free %	97	100			100	
cM capacity (veh/h)	946	999			1440	
<b>Direction, Lane #</b>						
	WB 1	NB 1	SB 1			
Volume Total	24	14	0			
Volume Left	24	0	0			
Volume Right	0	14	0			
cSH	946	1700	1700			
Volume to Capacity	0.03	0.01	0.00			
Queue Length 95th (m)	0.6	0.0	0.0			
Control Delay (s)	8.9	0.0	0.0			
Lane LOS	A					
Approach Delay (s)	8.9	0.0	0.0			
Approach LOS	A					
<b>Intersection Summary</b>						
Average Delay			5.6			
Intersection Capacity Utilization		13.3%		ICU Level of Service		A
Analysis Period (min)			15			



HCM Unsignalized Intersection Capacity Analysis  
3: Highway 88/Range Road 135 & Highway 58

2034 AM Peak - Background Traffic  
07/20/2021

												
Movement	EBL	EBT	EBR	WBL	WBT	WBR	NBL	NBT	NBR	SBL	SBT	SBR
Lane Configurations												
Traffic Volume (veh/h)	8	6	54	6	19	4	79	10	5	2	3	3
Future Volume (Veh/h)	8	6	54	6	19	4	79	10	5	2	3	3
Sign Control		Free			Free			Stop			Stop	
Grade		0%			0%			0%			0%	
Peak Hour Factor	0.92	0.92	0.92	0.92	0.92	0.92	0.92	0.92	0.92	0.92	0.92	0.92
Hourly flow rate (vph)	9	7	59	7	21	4	86	11	5	2	3	3
Pedestrians												
Lane Width (m)												
Walking Speed (m/s)												
Percent Blockage												
Right turn flare (veh)												
Median type		None			None							
Median storage (veh)												
Upstream signal (m)												
pX, platoon unblocked												
vC, conflicting volume	25			66			94	94	36	72	121	23
vC1, stage 1 conf vol												
vC2, stage 2 conf vol												
vCu, unblocked vol	25			66			94	94	36	72	121	23
tC, single (s)	4.4			4.4			7.4	6.8	6.5	7.4	6.8	6.5
tC, 2 stage (s)												
tF (s)	2.5			2.5			3.8	4.3	3.6	3.8	4.3	3.6
p0 queue free %	99			99			89	99	99	100	100	100
cM capacity (veh/h)	1426			1375			814	738	961	833	712	978
Direction, Lane #	EB 1	EB 2	WB 1	WB 2	NB 1	SB 1						
Volume Total	9	66	7	25	102	8						
Volume Left	9	0	7	0	86	2						
Volume Right	0	59	0	4	5	3						
cSH	1426	1700	1375	1700	811	826						
Volume to Capacity	0.01	0.04	0.01	0.01	0.13	0.01						
Queue Length 95th (m)	0.1	0.0	0.1	0.0	3.3	0.2						
Control Delay (s)	7.5	0.0	7.6	0.0	10.1	9.4						
Lane LOS	A		A		B	A						
Approach Delay (s)	0.9		1.7		10.1	9.4						
Approach LOS					B	A						
Intersection Summary												
Average Delay			5.6									
Intersection Capacity Utilization			25.8%	ICU Level of Service	A							
Analysis Period (min)			15									

HCM Unsignalized Intersection Capacity Analysis  
4: Range Road 135 & Phase 1 Access

2034 AM Peak - Background Traffic  
07/20/2021



Movement	WBL	WBR	NBT	NBR	SBL	SBT
Lane Configurations						
Traffic Volume (veh/h)	9	0	0	19	0	0
Future Volume (Veh/h)	9	0	0	19	0	0
Sign Control	Stop		Free		Free	
Grade	0%		0%		0%	
Peak Hour Factor	0.92	0.92	0.92	0.92	0.92	0.92
Hourly flow rate (vph)	10	0	0	21	0	0
<b>Pedestrians</b>						
Lane Width (m)						
Walking Speed (m/s)						
Percent Blockage						
Right turn flare (veh)						
Median type	None			None		
Median storage veh						
Upstream signal (m)						
pX, platoon unblocked						
vC, conflicting volume	10	10			21	
vC1, stage 1 conf vol						
vC2, stage 2 conf vol						
vCu, unblocked vol	10	10			21	
tC, single (s)	6.7	6.5			4.4	
tC, 2 stage (s)						
tF (s)	3.8	3.6			2.5	
p0 queue free %	99	100			100	
cM capacity (veh/h)	942	995			1431	
<b>Direction, Lane #</b>	<b>WB 1</b>	<b>NB 1</b>	<b>SB 1</b>			
Volume Total	10	21	0			
Volume Left	10	0	0			
Volume Right	0	21	0			
cSH	942	1700	1700			
Volume to Capacity	0.01	0.01	0.00			
Queue Length 95th (m)	0.2	0.0	0.0			
Control Delay (s)	8.9	0.0	0.0			
Lane LOS	A					
Approach Delay (s)	8.9	0.0	0.0			
Approach LOS	A					
<b>Intersection Summary</b>						
Average Delay			2.9			
Intersection Capacity Utilization			13.3%	ICU Level of Service	A	
Analysis Period (min)			15			

HCM Unsignalized Intersection Capacity Analysis  
 1: Highway 58 & East Access



















2034 PM Peak - Background Traffic  
 07/20/2021



Movement	EBL	EBT	WBT	WBR	SBL	SBR
Lane Configurations		↖	↗		↘	
Traffic Volume (veh/h)	0	0	0	0	0	0
Future Volume (Veh/h)	0	0	0	0	0	0
Sign Control		Free	Free		Stop	
Grade		0%	0%		0%	
Peak Hour Factor	0.92	0.92	0.92	0.92	0.92	0.92
Hourly flow rate (vph)	0	0	0	0	0	0
<b>Pedestrians</b>						
Lane Width (m)						
Walking Speed (m/s)						
Percent Blockage						
Right turn flare (veh)						
Median type		None	None			
Median storage (veh)						
Upstream signal (m)						
pX, platoon unblocked						
vC, conflicting volume	0				0	0
vC1, stage 1 conf vol						
vC2, stage 2 conf vol						
vCu, unblocked vol	0				0	0
tC, single (s)	4.4				6.7	6.5
tC, 2 stage (s)						
tF (s)	2.5				3.8	3.6
p0 queue free %	100				100	100
cM capacity (veh/h)	1457				955	1008
<b>Direction, Lane #</b>	<b>EB 1</b>	<b>WB 1</b>	<b>SB 1</b>			
Volume Total	0	0	0			
Volume Left	0	0	0			
Volume Right	0	0	0			
cSH	1700	1700	1700			
Volume to Capacity	0.00	0.00	0.00			
Queue Length 95th (m)	0.0	0.0	0.0			
Control Delay (s)	0.0	0.0	0.0			
Lane LOS			A			
Approach Delay (s)	0.0	0.0	0.0			
Approach LOS			A			
<b>Intersection Summary</b>						
Average Delay			0.0			
Intersection Capacity Utilization			0.0%	ICU Level of Service	A	
Analysis Period (min)			15			

HCM Unsignalized Intersection Capacity Analysis  
3: Highway 88/Range Road 135 & Highway 58

2034 PM Peak - Background Traffic  
07/20/2021

												
Movement	EBL	EBT	EBR	WBL	WBT	WBR	NBL	NBT	NBR	SBL	SBT	SBR
Lane Configurations												
Traffic Volume (veh/h)	5	12	72	8	6	3	67	7	15	4	9	9
Future Volume (Veh/h)	5	12	72	8	6	3	67	7	15	4	9	9
Sign Control		Free			Free			Stop			Stop	
Grade		0%			0%			0%			0%	
Peak Hour Factor	0.92	0.92	0.92	0.92	0.92	0.92	0.92	0.92	0.92	0.92	0.92	0.92
Hourly flow rate (vph)	5	13	78	9	7	3	73	8	16	4	10	10
Pedestrians												
Lane Width (m)												
Walking Speed (m/s)												
Percent Blockage												
Right turn flare (veh)												
Median type		None			None							
Median storage (veh)												
Upstream signal (m)												
pX, platoon unblocked												
vC, conflicting volume	10			91			102	90	52	70	128	8
vC1, stage 1 conf vol												
vC2, stage 2 conf vol												
vCu, unblocked vol	10			91			102	90	52	70	128	8
tC, single (s)	4.4			4.4			7.4	6.8	6.5	7.4	6.8	6.5
tC, 2 stage (s)												
tF (s)	2.5			2.5			3.8	4.3	3.6	3.8	4.3	3.6
p0 queue free %	100			99			91	99	98	100	99	99
cM capacity (veh/h)	1445			1345			793	742	942	830	707	997
Direction, Lane #	EB 1	EB 2	WB 1	WB 2	NB 1	SB 1						
Volume Total	5	91	9	10	97	24						
Volume Left	5	0	9	0	73	4						
Volume Right	0	78	0	3	16	10						
cSH	1445	1700	1345	1700	810	828						
Volume to Capacity	0.00	0.05	0.01	0.01	0.12	0.03						
Queue Length 95th (m)	0.1	0.0	0.2	0.0	3.1	0.7						
Control Delay (s)	7.5	0.0	7.7	0.0	10.0	9.5						
Lane LOS	A		A		B	A						
Approach Delay (s)	0.4		3.6		10.0	9.5						
Approach LOS					B	A						
Intersection Summary												
Average Delay			5.5									
Intersection Capacity Utilization			25.6%	ICU Level of Service	A							
Analysis Period (min)			15									

HCM Unsignalized Intersection Capacity Analysis  
4: Range Road 135 & Phase 1 Access



















2034 PM Peak - Background Traffic  
07/20/2021



Movement	WBL	WBR	NBT	NBR	SBL	SBT
Lane Configurations						
Traffic Volume (veh/h)	22	0	0	13	0	0
Future Volume (Veh/h)	22	0	0	13	0	0
Sign Control	Stop		Free		Free	
Grade	0%		0%		0%	
Peak Hour Factor	0.92	0.92	0.92	0.92	0.92	0.92
Hourly flow rate (vph)	24	0	0	14	0	0
Pedestrians						
Lane Width (m)						
Walking Speed (m/s)						
Percent Blockage						
Right turn flare (veh)						
Median type	None			None		
Median storage veh						
Upstream signal (m)						
pX, platoon unblocked						
vC, conflicting volume	7	7			14	
vC1, stage 1 conf vol						
vC2, stage 2 conf vol						
vCu, unblocked vol	7	7			14	
tC, single (s)	6.7	6.5			4.4	
tC, 2 stage (s)						
tF (s)	3.8	3.6			2.5	
p0 queue free %	97	100			100	
cM capacity (veh/h)	946	999			1440	
Direction, Lane #	WB 1	NB 1	SB 1			
Volume Total	24	14	0			
Volume Left	24	0	0			
Volume Right	0	14	0			
cSH	946	1700	1700			
Volume to Capacity	0.03	0.01	0.00			
Queue Length 95th (m)	0.6	0.0	0.0			
Control Delay (s)	8.9	0.0	0.0			
Lane LOS	A					
Approach Delay (s)	8.9	0.0	0.0			
Approach LOS	A					
Intersection Summary						
Average Delay			5.6			
Intersection Capacity Utilization		13.3%		ICU Level of Service		A
Analysis Period (min)			15			









HCM Unsignalized Intersection Capacity Analysis  
3: Highway 88/Range Road 135 & Highway 58

2044 AM Peak - Background Traffic  
07/20/2021

												
Movement	EBL	EBT	EBR	WBL	WBT	WBR	NBL	NBT	NBR	SBL	SBT	SBR
Lane Configurations												
Traffic Volume (veh/h)	8	7	62	7	22	4	92	11	6	2	3	3
Future Volume (Veh/h)	8	7	62	7	22	4	92	11	6	2	3	3
Sign Control		Free			Free			Stop			Stop	
Grade		0%			0%			0%			0%	
Peak Hour Factor	0.92	0.92	0.92	0.92	0.92	0.92	0.92	0.92	0.92	0.92	0.92	0.92
Hourly flow rate (vph)	9	8	67	8	24	4	100	12	7	2	3	3
Pedestrians												
Lane Width (m)												
Walking Speed (m/s)												
Percent Blockage												
Right turn flare (veh)												
Median type		None			None							
Median storage (veh)												
Upstream signal (m)												
pX, platoon unblocked												
vC, conflicting volume	28			75			104	104	42	81	135	26
vC1, stage 1 conf vol												
vC2, stage 2 conf vol												
vCu, unblocked vol	28			75			104	104	42	81	135	26
tC, single (s)	4.4			4.4			7.4	6.8	6.5	7.4	6.8	6.5
tC, 2 stage (s)												
tF (s)	2.5			2.5			3.8	4.3	3.6	3.8	4.3	3.6
p0 queue free %	99			99			88	98	99	100	100	100
cM capacity (veh/h)	1422			1364			801	728	955	819	698	975
Direction, Lane #	EB 1	EB 2	WB 1	WB 2	NB 1	SB 1						
Volume Total	9	75	8	28	119	8						
Volume Left	9	0	8	0	100	2						
Volume Right	0	67	0	4	7	3						
cSH	1422	1700	1364	1700	801	815						
Volume to Capacity	0.01	0.04	0.01	0.02	0.15	0.01						
Queue Length 95th (m)	0.1	0.0	0.1	0.0	4.0	0.2						
Control Delay (s)	7.5	0.0	7.7	0.0	10.3	9.5						
Lane LOS	A		A		B	A						
Approach Delay (s)	0.8		1.7		10.3	9.5						
Approach LOS					B	A						
Intersection Summary												
Average Delay			5.8									
Intersection Capacity Utilization			26.7%		ICU Level of Service				A			
Analysis Period (min)			15									

HCM Unsignalized Intersection Capacity Analysis  
4: Range Road 135 & Phase 1 Access

2044 AM Peak - Background Traffic  
07/20/2021

						
Movement	WBL	WBR	NBT	NBR	SBL	SBT
Lane Configurations						
Traffic Volume (veh/h)	9	0	0	19	0	0
Future Volume (Veh/h)	9	0	0	19	0	0
Sign Control	Stop		Free			Free
Grade	0%		0%			0%
Peak Hour Factor	0.92	0.92	0.92	0.92	0.92	0.92
Hourly flow rate (vph)	10	0	0	21	0	0
Pedestrians						
Lane Width (m)						
Walking Speed (m/s)						
Percent Blockage						
Right turn flare (veh)						
Median type			None			None
Median storage veh						
Upstream signal (m)						
pX, platoon unblocked						
vC, conflicting volume	10	10			21	
vC1, stage 1 conf vol						
vC2, stage 2 conf vol						
vCu, unblocked vol	10	10			21	
tC, single (s)	6.7	6.5			4.4	
tC, 2 stage (s)						
tF (s)	3.8	3.6			2.5	
p0 queue free %	99	100			100	
cM capacity (veh/h)	942	995			1431	
Direction, Lane #	WB 1	NB 1	SB 1			
Volume Total	10	21	0			
Volume Left	10	0	0			
Volume Right	0	21	0			
cSH	942	1700	1700			
Volume to Capacity	0.01	0.01	0.00			
Queue Length 95th (m)	0.2	0.0	0.0			
Control Delay (s)	8.9	0.0	0.0			
Lane LOS	A					
Approach Delay (s)	8.9	0.0	0.0			
Approach LOS	A					
Intersection Summary						
Average Delay			2.9			
Intersection Capacity Utilization			13.3%		ICU Level of Service	A
Analysis Period (min)			15			

HCM Unsignalized Intersection Capacity Analysis  
 1: Highway 58 & East Access

2044 PM Peak - Background Traffic  
 07/20/2021





















Movement	EBL	EBT	WBT	WBR	SBL	SBR
Lane Configurations						
Traffic Volume (veh/h)	0	0	0	0	0	0
Future Volume (Veh/h)	0	0	0	0	0	0
Sign Control		Free	Free		Stop	
Grade		0%	0%		0%	
Peak Hour Factor	0.92	0.92	0.92	0.92	0.92	0.92
Hourly flow rate (vph)	0	0	0	0	0	0
Pedestrians						
Lane Width (m)						
Walking Speed (m/s)						
Percent Blockage						
Right turn flare (veh)						
Median type		None	None			
Median storage (veh)						
Upstream signal (m)						
pX, platoon unblocked						
vC, conflicting volume	0				0	0
vC1, stage 1 conf vol						
vC2, stage 2 conf vol						
vCu, unblocked vol	0				0	0
tC, single (s)	4.4				6.7	6.5
tC, 2 stage (s)						
tF (s)	2.5				3.8	3.6
p0 queue free %	100				100	100
cM capacity (veh/h)	1457				955	1008
Direction, Lane #	EB 1	WB 1	SB 1			
Volume Total	0	0	0			
Volume Left	0	0	0			
Volume Right	0	0	0			
cSH	1700	1700	1700			
Volume to Capacity	0.00	0.00	0.00			
Queue Length 95th (m)	0.0	0.0	0.0			
Control Delay (s)	0.0	0.0	0.0			
Lane LOS			A			
Approach Delay (s)	0.0	0.0	0.0			
Approach LOS			A			
Intersection Summary						
Average Delay			0.0			
Intersection Capacity Utilization			0.0%	ICU Level of Service		A
Analysis Period (min)			15			











HCM Unsignalized Intersection Capacity Analysis  
 3: Highway 88/Range Road 135 & Highway 58

2044 PM Peak - Background Traffic  
 07/20/2021





















												
Movement	EBL	EBT	EBR	WBL	WBT	WBR	NBL	NBT	NBR	SBL	SBT	SBR
Lane Configurations												
Traffic Volume (veh/h)	5	13	83	9	7	3	77	8	18	4	9	9
Future Volume (Veh/h)	5	13	83	9	7	3	77	8	18	4	9	9
Sign Control		Free			Free			Stop			Stop	
Grade		0%			0%			0%			0%	
Peak Hour Factor	0.92	0.92	0.92	0.92	0.92	0.92	0.92	0.92	0.92	0.92	0.92	0.92
Hourly flow rate (vph)	5	14	90	10	8	3	84	9	20	4	10	10
Pedestrians												
Lane Width (m)												
Walking Speed (m/s)												
Percent Blockage												
Right turn flare (veh)												
Median type		None			None							
Median storage (veh)												
Upstream signal (m)												
pX, platoon unblocked												
vC, conflicting volume	11			104			112	100	59	78	144	10
vC1, stage 1 conf vol												
vC2, stage 2 conf vol												
vCu, unblocked vol	11			104			112	100	59	78	144	10
tC, single (s)	4.4			4.4			7.4	6.8	6.5	7.4	6.8	6.5
tC, 2 stage (s)												
tF (s)	2.5			2.5			3.8	4.3	3.6	3.8	4.3	3.6
p0 queue free %	100			99			89	99	98	100	99	99
cM capacity (veh/h)	1443			1330			780	732	933	814	692	996
Direction, Lane #	EB 1	EB 2	WB 1	WB 2	NB 1	SB 1						
Volume Total	5	104	10	11	113	24						
Volume Left	5	0	10	0	84	4						
Volume Right	0	90	0	3	20	10						
cSH	1443	1700	1330	1700	799	816						
Volume to Capacity	0.00	0.06	0.01	0.01	0.14	0.03						
Queue Length 95th (m)	0.1	0.0	0.2	0.0	3.7	0.7						
Control Delay (s)	7.5	0.0	7.7	0.0	10.2	9.5						
Lane LOS	A		A		B	A						
Approach Delay (s)	0.3		3.7		10.2	9.5						
Approach LOS					B	A						
Intersection Summary												
Average Delay			5.6									
Intersection Capacity Utilization			26.6%		ICU Level of Service				A			
Analysis Period (min)			15									

HCM Unsignalized Intersection Capacity Analysis  
4: Range Road 135 & Phase 1 Access

2044 PM Peak - Background Traffic  
07/20/2021

						
Movement	WBL	WBR	NBT	NBR	SBL	SBT
Lane Configurations						
Traffic Volume (veh/h)	22	0	0	13	0	0
Future Volume (Veh/h)	22	0	0	13	0	0
Sign Control	Stop		Free		Free	
Grade	0%		0%		0%	
Peak Hour Factor	0.92	0.92	0.92	0.92	0.92	0.92
Hourly flow rate (vph)	24	0	0	14	0	0
<b>Pedestrians</b>						
Lane Width (m)						
Walking Speed (m/s)						
Percent Blockage						
Right turn flare (veh)						
Median type			None		None	
Median storage (veh)						
Upstream signal (m)						
pX, platoon unblocked						
vC, conflicting volume	7	7			14	
vC1, stage 1 conf vol						
vC2, stage 2 conf vol						
vCu, unblocked vol	7	7			14	
tC, single (s)	6.7	6.5			4.4	
tC, 2 stage (s)						
tF (s)	3.8	3.6			2.5	
p0 queue free %	97	100			100	
cM capacity (veh/h)	946	999			1440	
<b>Direction, Lane #</b>	<b>WB 1</b>	<b>NB 1</b>	<b>SB 1</b>			
Volume Total	24	14	0			
Volume Left	24	0	0			
Volume Right	0	14	0			
cSH	946	1700	1700			
Volume to Capacity	0.03	0.01	0.00			
Queue Length 95th (m)	0.6	0.0	0.0			
Control Delay (s)	8.9	0.0	0.0			
Lane LOS	A					
Approach Delay (s)	8.9	0.0	0.0			
Approach LOS	A					
<b>Intersection Summary</b>						
Average Delay			5.6			
Intersection Capacity Utilization		13.3%		ICU Level of Service		A
Analysis Period (min)			15			

HCM Unsignalized Intersection Capacity Analysis 2024 AM Peak - Post Development Traffic  
 3: Highway 88/Range Road 135 & Highway 58 07/20/2021





















												
Movement	EBL	EBT	EBR	WBL	WBT	WBR	NBL	NBT	NBR	SBL	SBT	SBR
Lane Configurations												
Traffic Volume (veh/h)	77	5	45	5	16	39	67	77	4	30	60	60
Future Volume (Veh/h)	77	5	45	5	16	39	67	77	4	30	60	60
Sign Control		Free			Free			Stop			Stop	
Grade		0%			0%			0%			0%	
Peak Hour Factor	0.92	0.92	0.92	0.92	0.92	0.92	0.92	0.92	0.92	0.92	0.92	0.92
Hourly flow rate (vph)	84	5	49	5	17	42	73	84	4	33	65	65
Pedestrians												
Lane Width (m)												
Walking Speed (m/s)												
Percent Blockage												
Right turn flare (veh)												
Median type		None			None							
Median storage (veh)												
Upstream signal (m)												
pX, platoon unblocked												
vC, conflicting volume	59			54			298	242	5	246	249	17
vC1, stage 1 conf vol												
vC2, stage 2 conf vol												
vCu, unblocked vol	59			54			298	242	5	246	249	17
tC, single (s)	4.4			4.4			7.4	6.8	6.5	7.4	6.8	6.5
tC, 2 stage (s)												
tF (s)	2.5			2.5			3.8	4.3	3.6	3.8	4.3	3.6
p0 queue free %	94			100			85	85	100	94	89	93
cM capacity (veh/h)	1384			1390			489	575	1002	550	569	986
Direction, Lane #	EB 1	EB 2	EB 3	WB 1	WB 2	WB 3	NB 1	SB 1				
Volume Total	84	5	49	5	17	42	161	163				
Volume Left	84	0	0	5	0	0	73	33				
Volume Right	0	0	49	0	0	42	4	65				
cSH	1384	1700	1700	1390	1700	1700	538	679				
Volume to Capacity	0.06	0.00	0.03	0.00	0.01	0.02	0.30	0.24				
Queue Length 95th (m)	1.5	0.0	0.0	0.1	0.0	0.0	9.5	7.1				
Control Delay (s)	7.8	0.0	0.0	7.6	0.0	0.0	14.5	12.0				
Lane LOS	A			A			B	B				
Approach Delay (s)	4.7			0.6			14.5	12.0				
Approach LOS							B	B				
Intersection Summary												
Average Delay			9.5									
Intersection Capacity Utilization			32.9%	ICU Level of Service		A						
Analysis Period (min)	15											

HCM Unsignalized Intersection Capacity Analysis 2024 AM Peak - Post Development Traffic  
 4: Range Road 135 & Phase 1 Access 07/20/2021



Movement	WBL	WBR	NBT	NBR	SBL	SBT
Lane Configurations	W		T			T
Traffic Volume (veh/h)	151	0	0	192	0	0
Future Volume (Veh/h)	151	0	0	192	0	0
Sign Control	Stop		Free			Free
Grade	0%		0%			0%
Peak Hour Factor	0.92	0.92	0.92	0.92	0.92	0.92
Hourly flow rate (vph)	164	0	0	209	0	0
<b>Pedestrians</b>						
Lane Width (m)						
Walking Speed (m/s)						
Percent Blockage						
Right turn flare (veh)						
Median type	None			None		
Median storage veh						
Upstream signal (m)						
pX, platoon unblocked						
vC, conflicting volume	104	104			209	
vC1, stage 1 conf vol						
vC2, stage 2 conf vol						
vCu, unblocked vol	104	104			209	
tC, single (s)	6.7	6.5			4.4	
tC, 2 stage (s)						
tF (s)	3.8	3.6			2.5	
p0 queue free %	80	100			100	
cM capacity (veh/h)	830	879			1212	
<b>Direction, Lane #</b>	<b>WB 1</b>	<b>NB 1</b>	<b>SB 1</b>			
Volume Total	164	209	0			
Volume Left	164	0	0			
Volume Right	0	209	0			
cSH	830	1700	1700			
Volume to Capacity	0.20	0.12	0.00			
Queue Length 95th (m)	5.6	0.0	0.0			
Control Delay (s)	10.4	0.0	0.0			
Lane LOS	B					
Approach Delay (s)	10.4	0.0	0.0			
Approach LOS	B					
<b>Intersection Summary</b>						
Average Delay			4.6			
Intersection Capacity Utilization			28.0%	ICU Level of Service	A	
Analysis Period (min)			15			

HCM Unsignalized Intersection Capacity Analysis 2024 PM Peak - Post Development Traffic  
 3: Highway 88/Range Road 135 & Highway 58 07/20/2021





















												
Movement	EBL	EBT	EBR	WBL	WBT	WBR	NBL	NBT	NBR	SBL	SBT	SBR
Lane Configurations												
Traffic Volume (veh/h)	92	10	60	6	5	47	56	93	13	46	93	93
Future Volume (Veh/h)	92	10	60	6	5	47	56	93	13	46	93	93
Sign Control		Free			Free			Stop			Stop	
Grade		0%			0%			0%			0%	
Peak Hour Factor	0.92	0.92	0.92	0.92	0.92	0.92	0.92	0.92	0.92	0.92	0.92	0.92
Hourly flow rate (vph)	100	11	65	7	5	51	61	101	14	50	101	101
Pedestrians												
Lane Width (m)												
Walking Speed (m/s)												
Percent Blockage												
Right turn flare (veh)												
Median type		None			None							
Median storage (veh)												
Upstream signal (m)												
pX, platoon unblocked												
vC, conflicting volume	56			76			382	281	11	294	295	5
vC1, stage 1 conf vol												
vC2, stage 2 conf vol												
vCu, unblocked vol	56			76			382	281	11	294	295	5
tC, single (s)	4.4			4.4			7.4	6.8	6.5	7.4	6.8	6.5
tC, 2 stage (s)												
tF (s)	2.5			2.5			3.8	4.3	3.6	3.8	4.3	3.6
p0 queue free %	93			99			84	81	99	90	81	90
cM capacity (veh/h)	1387			1363			383	538	994	482	528	1002
Direction, Lane #	EB 1	EB 2	EB 3	WB 1	WB 2	WB 3	NB 1	SB 1				
Volume Total	100	11	65	7	5	51	176	252				
Volume Left	100	0	0	7	0	0	61	50				
Volume Right	0	0	65	0	0	51	14	101				
cSH	1387	1700	1700	1363	1700	1700	487	637				
Volume to Capacity	0.07	0.01	0.04	0.01	0.00	0.03	0.36	0.40				
Queue Length 95th (m)	1.8	0.0	0.0	0.1	0.0	0.0	12.4	14.4				
Control Delay (s)	7.8	0.0	0.0	7.7	0.0	0.0	16.5	14.3				
Lane LOS	A			A			C	B				
Approach Delay (s)	4.4			0.9			16.5	14.3				
Approach LOS							C	B				
Intersection Summary												
Average Delay			11.0									
Intersection Capacity Utilization			34.5%			ICU Level of Service		A				
Analysis Period (min)			15									

HCM Unsignalized Intersection Capacity Analysis 2024 PM Peak - Post Development Traffic  
 4: Range Road 135 & Phase 1 Access 07/20/2021



Movement	WBL	WBR	NBT	NBR	SBL	SBT
Lane Configurations	W		T			R
Traffic Volume (veh/h)	231	0	0	231	0	0
Future Volume (Veh/h)	231	0	0	231	0	0
Sign Control	Stop		Free		Free	
Grade	0%		0%		0%	
Peak Hour Factor	0.92	0.92	0.92	0.92	0.92	0.92
Hourly flow rate (vph)	251	0	0	251	0	0
<b>Pedestrians</b>						
Lane Width (m)						
Walking Speed (m/s)						
Percent Blockage						
Right turn flare (veh)						
Median type	None			None		
Median storage veh						
Upstream signal (m)						
pX, platoon unblocked						
vC, conflicting volume	126	126			251	
vC1, stage 1 conf vol						
vC2, stage 2 conf vol						
vCu, unblocked vol	126	126			251	
tC, single (s)	6.7	6.5			4.4	
tC, 2 stage (s)						
tF (s)	3.8	3.6			2.5	
p0 queue free %	69	100			100	
cM capacity (veh/h)	807	855			1167	
<b>Direction, Lane #</b>	<b>WB 1</b>	<b>NB 1</b>	<b>SB 1</b>			
Volume Total	251	251	0			
Volume Left	251	0	0			
Volume Right	0	251	0			
cSH	807	1700	1700			
Volume to Capacity	0.31	0.15	0.00			
Queue Length 95th (m)	10.1	0.0	0.0			
Control Delay (s)	11.5	0.0	0.0			
Lane LOS	B					
Approach Delay (s)	11.5	0.0	0.0			
Approach LOS	B					
<b>Intersection Summary</b>						
Average Delay			5.7			
Intersection Capacity Utilization			35.3%		ICU Level of Service	A
Analysis Period (min)			15			

HCM Unsignalized Intersection Capacity Analysis 2034 AM Peak - Post Development Traffic  
 3: Highway 88/Range Road 135 & Highway 58 07/20/2021

													
Movement	EBL	EBT	EBR	WBL	WBT	WBR	NBL	NBT	NBR	SBL	SBT	SBR	
Lane Configurations													
Traffic Volume (veh/h)	90	6	54	6	19	46	79	92	5	33	65	65	
Future Volume (Veh/h)	90	6	54	6	19	46	79	92	5	33	65	65	
Sign Control		Free			Free			Stop			Stop		
Grade		0%			0%			0%			0%		
Peak Hour Factor	0.92	0.92	0.92	0.92	0.92	0.92	0.92	0.92	0.92	0.92	0.92	0.92	
Hourly flow rate (vph)	98	7	59	7	21	50	86	100	5	36	71	71	
Pedestrians													
Lane Width (m)													
Walking Speed (m/s)													
Percent Blockage													
Right turn flare (veh)													
Median type	None			None									
Median storage (veh)													
Upstream signal (m)													
pX, platoon unblocked													
vC, conflicting volume	71			66			344	288	7	293	297	21	
vC1, stage 1 conf vol													
vC2, stage 2 conf vol													
vCu, unblocked vol	71			66			344	288	7	293	297	21	
tC, single (s)	4.4			4.4			7.4	6.8	6.5	7.4	6.8	6.5	
tC, 2 stage (s)													
tF (s)	2.5			2.5			3.8	4.3	3.6	3.8	4.3	3.6	
p0 queue free %	93			99			80	81	99	93	87	93	
cM capacity (veh/h)	1369			1375			439	534	999	488	527	981	
Direction, Lane #	EB 1	EB 2	EB 3	WB 1	WB 2	WB 3	NB 1	SB 1					
Volume Total	98	7	59	7	21	50	191	178					
Volume Left	98	0	0	7	0	0	86	36					
Volume Right	0	0	59	0	0	50	5	71					
cSH	1369	1700	1700	1375	1700	1700	492	634					
Volume to Capacity	0.07	0.00	0.03	0.01	0.01	0.03	0.39	0.28					
Queue Length 95th (m)	1.8	0.0	0.0	0.1	0.0	0.0	13.8	8.7					
Control Delay (s)	7.8	0.0	0.0	7.6	0.0	0.0	16.9	12.9					
Lane LOS	A			A			C	B					
Approach Delay (s)	4.7			0.7			16.9	12.9					
Approach LOS							C	B					
Intersection Summary													
Average Delay			10.4										
Intersection Capacity Utilization		38.5%		ICU Level of Service					A				
Analysis Period (min)			15										

HCM Unsignalized Intersection Capacity Analysis 2034 AM Peak - Post Development Traffic  
 4: Range Road 135 & Phase 1 Access

07/20/2021



Movement	WBL	WBR	NBT	NBR	SBL	SBT
Lane Configurations						
Traffic Volume (veh/h)	164	0	0	225	0	0
Future Volume (Veh/h)	164	0	0	225	0	0
Sign Control	Stop		Free			Free
Grade	0%		0%			0%
Peak Hour Factor	0.92	0.92	0.92	0.92	0.92	0.92
Hourly flow rate (vph)	178	0	0	245	0	0
<b>Pedestrians</b>						
Lane Width (m)						
Walking Speed (m/s)						
Percent Blockage						
Right turn flare (veh)						
Median type	None			None		
Median storage (veh)						
Upstream signal (m)						
pX, platoon unblocked						
vC, conflicting volume	122	122			245	
vC1, stage 1 conf vol						
vC2, stage 2 conf vol						
vCu, unblocked vol	122	122			245	
tC, single (s)	6.7	6.5			4.4	
tC, 2 stage (s)						
tF (s)	3.8	3.6			2.5	
p0 queue free %	78	100			100	
cM capacity (veh/h)	810	858			1174	
<b>Direction, Lane #</b>	<b>WB 1</b>	<b>NB 1</b>	<b>SB 1</b>			
Volume Total	178	245	0			
Volume Left	178	0	0			
Volume Right	0	245	0			
cSH	810	1700	1700			
Volume to Capacity	0.22	0.14	0.00			
Queue Length 95th (m)	6.4	0.0	0.0			
Control Delay (s)	10.7	0.0	0.0			
Lane LOS	B					
Approach Delay (s)	10.7	0.0	0.0			
Approach LOS	B					
<b>Intersection Summary</b>						
Average Delay			4.5			
Intersection Capacity Utilization			31.0%	ICU Level of Service	A	
Analysis Period (min)			15			



HCM Unsignalized Intersection Capacity Analysis 2034 PM Peak - Post Development Traffic  
 3: Highway 88/Range Road 135 & Highway 58 07/20/2021

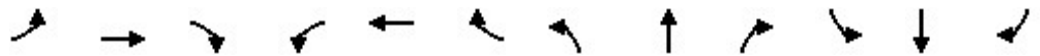





















Movement	EBL	EBT	EBR	WBL	WBT	WBR	NBL	NBT	NBR	SBL	SBT	SBR						
Lane Configurations																		
Traffic Volume (veh/h)	100	12	72	8	6	51	67	102	15	53	107	107						
Future Volume (Veh/h)	100	12	72	8	6	51	67	102	15	53	107	107						
Sign Control		Free			Free			Stop			Stop							
Grade		0%			0%			0%			0%							
Peak Hour Factor	0.92	0.92	0.92	0.92	0.92	0.92	0.92	0.92	0.92	0.92	0.92	0.92						
Hourly flow rate (vph)	109	13	78	9	7	55	73	111	16	58	116	116						
Pedestrians																		
Lane Width (m)																		
Walking Speed (m/s)																		
Percent Blockage																		
Right turn flare (veh)																		
Median type	None			None														
Median storage (veh)																		
Upstream signal (m)																		
pX, platoon unblocked																		
vC, conflicting volume	62		91			430		311		13		328		334		7		
vC1, stage 1 conf vol																		
vC2, stage 2 conf vol																		
vCu, unblocked vol	62		91			430		311		13		328		334		7		
tC, single (s)	4.4		4.4			7.4		6.8		6.5		7.4		6.8		6.5		
tC, 2 stage (s)																		
tF (s)	2.5		2.5			3.8		4.3		3.6		3.8		4.3		3.6		
p0 queue free %	92		99			78		78		98		87		77		88		
cM capacity (veh/h)	1380		1345			333		513		991		442		497		999		
Direction, Lane #	EB 1	EB 2	EB 3	WB 1	WB 2	WB 3	NB 1	SB 1										
Volume Total	109	13	78	9	7	55	200	290										
Volume Left	109	0	0	9	0	0	73	58										
Volume Right	0	0	78	0	0	55	16	116										
cSH	1380	1700	1700	1345	1700	1700	443	603										
Volume to Capacity	0.08	0.01	0.05	0.01	0.00	0.03	0.45	0.48										
Queue Length 95th (m)	2.0	0.0	0.0	0.2	0.0	0.0	17.5	19.8										
Control Delay (s)	7.8	0.0	0.0	7.7	0.0	0.0	19.7	16.4										
Lane LOS	A			A			C		C									
Approach Delay (s)	4.3		1.0			19.7		16.4										
Approach LOS	C		C			C		C										
Intersection Summary																		
Average Delay			12.6															
Intersection Capacity Utilization			37.7%			ICU Level of Service		A										
Analysis Period (min)			15															

HCM Unsignalized Intersection Capacity Analysis 2034 PM Peak - Post Development Traffic  
 4: Range Road 135 & Phase 1 Access 07/20/2021



Movement	WBL	WBR	NBT	NBR	SBL	SBT
Lane Configurations						
Traffic Volume (veh/h)	265	0	0	251	0	0
Future Volume (Veh/h)	265	0	0	251	0	0
Sign Control	Stop		Free			Free
Grade	0%		0%			0%
Peak Hour Factor	0.92	0.92	0.92	0.92	0.92	0.92
Hourly flow rate (vph)	288	0	0	273	0	0
<b>Pedestrians</b>						
Lane Width (m)						
Walking Speed (m/s)						
Percent Blockage						
Right turn flare (veh)						
Median type	None			None		
Median storage (veh)						
Upstream signal (m)						
pX, platoon unblocked						
vC, conflicting volume	136	136			273	
vC1, stage 1 conf vol						
vC2, stage 2 conf vol						
vCu, unblocked vol	136	136			273	
tC, single (s)	6.7	6.5			4.4	
tC, 2 stage (s)						
tF (s)	3.8	3.6			2.5	
p0 queue free %	64	100			100	
cM capacity (veh/h)	795	843			1145	
<b>Direction, Lane #</b>	<b>WB 1</b>	<b>NB 1</b>	<b>SB 1</b>			
Volume Total	288	273	0			
Volume Left	288	0	0			
Volume Right	0	273	0			
cSH	795	1700	1700			
Volume to Capacity	0.36	0.16	0.00			
Queue Length 95th (m)	12.6	0.0	0.0			
Control Delay (s)	12.1	0.0	0.0			
Lane LOS	B					
Approach Delay (s)	12.1	0.0	0.0			
Approach LOS	B					
<b>Intersection Summary</b>						
Average Delay			6.2			
Intersection Capacity Utilization			38.6%	ICU Level of Service	A	
Analysis Period (min)			15			

HCM Unsignalized Intersection Capacity Analysis 2044 AM Peak - Post Development Traffic  
 3: Highway 88/Range Road 135 & Highway 58 07/20/2021

												
Movement	EBL	EBT	EBR	WBL	WBT	WBR	NBL	NBT	NBR	SBL	SBT	SBR
Lane Configurations												
Traffic Volume (veh/h)	136	19	62	9	24	69	92	139	18	36	71	71
Future Volume (Veh/h)	136	19	62	9	24	69	92	139	18	36	71	71
Sign Control		Free			Free			Stop			Stop	
Grade		0%			0%			0%			0%	
Peak Hour Factor	0.92	0.92	0.92	0.92	0.92	0.92	0.92	0.92	0.92	0.92	0.92	0.92
Hourly flow rate (vph)	148	21	67	10	26	75	100	151	20	39	77	77
Pedestrians												
Lane Width (m)												
Walking Speed (m/s)												
Percent Blockage												
Right turn flare (veh)												
Median type	None			None								
Median storage veh												
Upstream signal (m)												
pX, platoon unblocked												
vC, conflicting volume	101			88			478	438	21	458	430	26
vC1, stage 1 conf vol												
vC2, stage 2 conf vol												
vCu, unblocked vol	101			88			478	438	21	458	430	26
tC, single (s)	4.4			4.4			7.4	6.8	6.5	7.4	6.8	6.5
tC, 2 stage (s)												
tF (s)	2.5			2.5			3.8	4.3	3.6	3.8	4.3	3.6
p0 queue free %	89			99			70	64	98	87	82	92
cM capacity (veh/h)	1333			1349			328	417	981	302	422	975
Direction, Lane #	EB 1	EB 2	EB 3	WB 1	WB 2	WB 3	NB 1	SB 1				
Volume Total	148	21	67	10	26	75	271	193				
Volume Left	148	0	0	10	0	0	100	39				
Volume Right	0	0	67	0	0	75	20	77				
cSH	1333	1700	1700	1349	1700	1700	394	494				
Volume to Capacity	0.11	0.01	0.04	0.01	0.02	0.04	0.69	0.39				
Queue Length 95th (m)	2.8	0.0	0.0	0.2	0.0	0.0	37.9	13.9				
Control Delay (s)	8.0	0.0	0.0	7.7	0.0	0.0	31.9	16.9				
Lane LOS	A			A			D	C				
Approach Delay (s)	5.0			0.7			31.9	16.9				
Approach LOS							D	C				
Intersection Summary												
Average Delay			16.3									
Intersection Capacity Utilization		46.3%		ICU Level of Service			A					
Analysis Period (min)		15										

HCM Unsignalized Intersection Capacity Analysis 2044 AM Peak - Post Development Traffic  
 4: Range Road 135 & Phase 1 Access 07/20/2021



Movement	WBL	WBR	NBT	NBR	SBL	SBT
Lane Configurations						
Traffic Volume (veh/h)	164	10	115	225	10	16
Future Volume (Veh/h)	164	10	115	225	10	16
Sign Control	Stop		Free		Free	
Grade	0%		0%		0%	
Peak Hour Factor	0.92	0.92	0.92	0.92	0.92	0.92
Hourly flow rate (vph)	178	11	125	245	11	17
<b>Pedestrians</b>						
Lane Width (m)						
Walking Speed (m/s)						
Percent Blockage						
Right turn flare (veh)						
Median type	None			None		
Median storage veh						
Upstream signal (m)						
pX, platoon unblocked						
vC, conflicting volume	286	248			370	
vC1, stage 1 conf vol						
vC2, stage 2 conf vol						
vCu, unblocked vol	286	248			370	
tC, single (s)	6.7	6.5			4.4	
tC, 2 stage (s)						
tF (s)	3.8	3.6			2.5	
p0 queue free %	72	98			99	
cM capacity (veh/h)	642	727			1050	
<b>Direction, Lane #</b>	<b>WB 1</b>	<b>NB 1</b>	<b>SB 1</b>			
Volume Total	189	370	28			
Volume Left	178	0	11			
Volume Right	11	245	0			
cSH	646	1700	1050			
Volume to Capacity	0.29	0.22	0.01			
Queue Length 95th (m)	9.2	0.0	0.2			
Control Delay (s)	12.9	0.0	3.4			
Lane LOS	B		A			
Approach Delay (s)	12.9	0.0	3.4			
Approach LOS	B					
<b>Intersection Summary</b>						
Average Delay			4.3			
Intersection Capacity Utilization			37.9%	ICU Level of Service		A
Analysis Period (min)	15					

HCM Unsignalized Intersection Capacity Analysis 2044 PM Peak - Post Development Traffic  
 3: Highway 88/Range Road 135 & Highway 58 07/20/2021

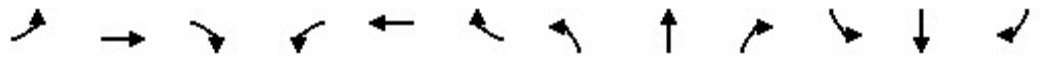

Movement	EBL	EBT	EBR	WBL	WBT	WBR	NBL	NBT	NBR	SBL	SBT	SBR						
Lane Configurations																		
Traffic Volume (veh/h)	106	15	83	19	17	54	77	109	20	74	148	148						
Future Volume (Veh/h)	106	15	83	19	17	54	77	109	20	74	148	148						
Sign Control		Free			Free			Stop			Stop							
Grade		0%			0%			0%			0%							
Peak Hour Factor	0.92	0.92	0.92	0.92	0.92	0.92	0.92	0.92	0.92	0.92	0.92	0.92						
Hourly flow rate (vph)	115	16	90	21	18	59	84	118	22	80	161	161						
Pedestrians																		
Lane Width (m)																		
Walking Speed (m/s)																		
Percent Blockage																		
Right turn flare (veh)																		
Median type	None			None														
Median storage (veh)																		
Upstream signal (m)																		
pX, platoon unblocked																		
vC, conflicting volume	77		106			548		365		16		387		396		18		
vC1, stage 1 conf vol																		
vC2, stage 2 conf vol																		
vCu, unblocked vol	77		106			548		365		16		387		396		18		
tC, single (s)	4.4		4.4			7.4		6.8		6.5		7.4		6.8		6.5		
tC, 2 stage (s)																		
tF (s)	2.5		2.5			3.8		4.3		3.6		3.8		4.3		3.6		
p0 queue free %	92		98			63		75		98		79		64		84		
cM capacity (veh/h)	1362		1328			229		470		987		383		451		985		
Direction, Lane #	EB 1	EB 2	EB 3	WB 1	WB 2	WB 3	NB 1	SB 1										
Volume Total	115	16	90	21	18	59	224	402										
Volume Left	115	0	0	21	0	0	84	80										
Volume Right	0	0	90	0	0	59	22	161										
cSH	1362	1700	1700	1328	1700	1700	350	551										
Volume to Capacity	0.08	0.01	0.05	0.02	0.01	0.03	0.64	0.73										
Queue Length 95th (m)	2.1	0.0	0.0	0.4	0.0	0.0	32.1	46.3										
Control Delay (s)	7.9	0.0	0.0	7.8	0.0	0.0	32.0	27.1										
Lane LOS	A			A			D		D									
Approach Delay (s)	4.1		1.7			32.0		27.1										
Approach LOS	D		D			D		D										
Intersection Summary																		
Average Delay	20.3																	
Intersection Capacity Utilization	44.1%			ICU Level of Service					A									
Analysis Period (min)	15																	

HCM Unsignalized Intersection Capacity Analysis 2044 PM Peak - Post Development Traffic  
 4: Range Road 135 & Phase 1 Access 07/20/2021



Movement	WBL	WBR	NBT	NBR	SBL	SBT
Lane Configurations						
Traffic Volume (veh/h)	255	10	15	250	10	103
Future Volume (Veh/h)	255	10	15	250	10	103
Sign Control	Stop		Free			Free
Grade	0%		0%			0%
Peak Hour Factor	0.92	0.92	0.92	0.92	0.92	0.92
Hourly flow rate (vph)	277	11	16	272	11	112
<b>Pedestrians</b>						
Lane Width (m)						
Walking Speed (m/s)						
Percent Blockage						
Right turn flare (veh)						
Median type	None			None		
Median storage veh						
Upstream signal (m)						
pX, platoon unblocked						
vC, conflicting volume	286	152			288	
vC1, stage 1 conf vol						
vC2, stage 2 conf vol						
vCu, unblocked vol	286	152			288	
tC, single (s)	6.7	6.5			4.4	
tC, 2 stage (s)						
tF (s)	3.8	3.6			2.5	
p0 queue free %	57	99			99	
cM capacity (veh/h)	643	826			1130	
<b>Direction, Lane #</b>	<b>WB 1</b>	<b>NB 1</b>	<b>SB 1</b>			
Volume Total	288	288	123			
Volume Left	277	0	11			
Volume Right	11	272	0			
cSH	648	1700	1130			
Volume to Capacity	0.44	0.17	0.01			
Queue Length 95th (m)	17.4	0.0	0.2			
Control Delay (s)	14.9	0.0	0.8			
Lane LOS	B		A			
Approach Delay (s)	14.9	0.0	0.8			
Approach LOS	B					
<b>Intersection Summary</b>						
Average Delay			6.3			
Intersection Capacity Utilization			39.4%	ICU Level of Service	A	
Analysis Period (min)			15			

HCM Unsignalized Intersection Capacity Analysis  
 1: Highway 58 & East Access





















2044 AM Peak - Senestivity PD Traffic  
 07/26/2021



Movement	EBL	EBT	WBT	WBR	SBL	SBR
Lane Configurations		↔	↔		↔	
Traffic Volume (veh/h)	0	49	101	0	0	0
Future Volume (Veh/h)	0	49	101	0	0	0
Sign Control		Free	Free		Stop	
Grade		0%	0%		0%	
Peak Hour Factor	0.92	0.92	0.92	0.92	0.92	0.92
Hourly flow rate (vph)	0	53	110	0	0	0
<b>Pedestrians</b>						
Lane Width (m)						
Walking Speed (m/s)						
Percent Blockage						
Right turn flare (veh)						
Median type		None	None			
Median storage veh						
Upstream signal (m)						
pX, platoon unblocked						
vC, conflicting volume	110				163	110
vC1, stage 1 conf vol						
vC2, stage 2 conf vol						
vCu, unblocked vol	110				163	110
tC, single (s)	4.4				6.7	6.5
tC, 2 stage (s)						
tF (s)	2.5				3.8	3.6
p0 queue free %	100				100	100
cM capacity (veh/h)	1323				767	873
<b>Direction, Lane #</b>	<b>EB 1</b>	<b>WB 1</b>	<b>SB 1</b>			
Volume Total	53	110	0			
Volume Left	0	0	0			
Volume Right	0	0	0			
cSH	1323	1700	1700			
Volume to Capacity	0.00	0.06	0.00			
Queue Length 95th (m)	0.0	0.0	0.0			
Control Delay (s)	0.0	0.0	0.0			
Lane LOS			A			
Approach Delay (s)	0.0	0.0	0.0			
Approach LOS			A			
<b>Intersection Summary</b>						
Average Delay			0.0			
Intersection Capacity Utilization			8.9%	ICU Level of Service	A	
Analysis Period (min)			15			

HCM Unsignalized Intersection Capacity Analysis  
 3: Highway 88/Range Road 135 & Highway 58

2044 AM Peak - Senestivity PD Traffic  
 07/26/2021

																
Movement	EBL	EBT	EBR	WBL	WBT	WBR	NBL	NBT	NBR	SBL	SBT	SBR				
Lane Configurations																
Traffic Volume (veh/h)	148	7	62	7	22	75	92	151	6	37	73	73				
Future Volume (Veh/h)	148	7	62	7	22	75	92	151	6	37	73	73				
Sign Control		Free			Free			Stop			Stop					
Grade		0%			0%			0%			0%					
Peak Hour Factor	0.92	0.92	0.92	0.92	0.92	0.92	0.92	0.92	0.92	0.92	0.92	0.92				
Hourly flow rate (vph)	161	8	67	8	24	82	100	164	7	40	79	79				
Pedestrians																
Lane Width (m)																
Walking Speed (m/s)																
Percent Blockage																
Right turn flare (veh)																
Median type	None					None										
Median storage (veh)																
Upstream signal (m)																
pX, platoon unblocked																
vC, conflicting volume	106		75		488		452		8		459		437		24	
vC1, stage 1 conf vol																
vC2, stage 2 conf vol																
vCu, unblocked vol	106		75		488		452		8		459		437		24	
tC, single (s)	4.4		4.4		7.4		6.8		6.5		7.4		6.8		6.5	
tC, 2 stage (s)																
tF (s)	2.5		2.5		3.8		4.3		3.6		3.8		4.3		3.6	
p0 queue free %	88		99		69		60		99		86		81		92	
cM capacity (veh/h)	1328		1364		318		405		998		290		413		977	
Direction, Lane #	EB 1	EB 2	EB 3	WB 1	WB 2	WB 3	NB 1	SB 1								
Volume Total	161	8	67	8	24	82	271	198								
Volume Left	161	0	0	8	0	0	100	40								
Volume Right	0	0	67	0	0	82	7	79								
cSH	1328	1700	1700	1364	1700	1700	373	483								
Volume to Capacity	0.12	0.00	0.04	0.01	0.01	0.05	0.73	0.41								
Queue Length 95th (m)	3.1	0.0	0.0	0.1	0.0	0.0	42.2	15.0								
Control Delay (s)	8.1	0.0	0.0	7.7	0.0	0.0	36.5	17.5								
Lane LOS	A		A		E		C									
Approach Delay (s)	5.5		0.5		36.5		17.5									
Approach LOS	E		C													
Intersection Summary																
Average Delay	18.0															
Intersection Capacity Utilization	46.8%		ICU Level of Service					A								
Analysis Period (min)	15															



HCM Unsignalized Intersection Capacity Analysis  
4: Range Road 135 & Phase 1 Access

2044 AM Peak - Senestivity PD Traffic  
07/26/2021



Movement	WBL	WBR	NBT	NBR	SBL	SBT
Lane Configurations						
Traffic Volume (veh/h)	164	10	145	215	10	20
Future Volume (Veh/h)	164	10	145	215	10	20
Sign Control	Stop		Free		Free	
Grade	0%		0%		0%	
Peak Hour Factor	0.92	0.92	0.92	0.92	0.92	0.92
Hourly flow rate (vph)	178	11	158	234	11	22
<b>Pedestrians</b>						
Lane Width (m)						
Walking Speed (m/s)						
Percent Blockage						
Right turn flare (veh)						
Median type	None			None		
Median storage veh						
Upstream signal (m)						
pX, platoon unblocked						
vC, conflicting volume	319	275			392	
vC1, stage 1 conf vol						
vC2, stage 2 conf vol						
vCu, unblocked vol	319	275			392	
tC, single (s)	6.7	6.5			4.4	
tC, 2 stage (s)						
tF (s)	3.8	3.6			2.5	
p0 queue free %	71	98			99	
cM capacity (veh/h)	614	701			1029	
<b>Direction, Lane #</b>	<b>WB 1</b>	<b>NB 1</b>	<b>SB 1</b>			
Volume Total	189	392	33			
Volume Left	178	0	11			
Volume Right	11	234	0			
cSH	618	1700	1029			
Volume to Capacity	0.31	0.23	0.01			
Queue Length 95th (m)	9.8	0.0	0.2			
Control Delay (s)	13.4	0.0	2.9			
Lane LOS	B		A			
Approach Delay (s)	13.4	0.0	2.9			
Approach LOS	B					
<b>Intersection Summary</b>						
Average Delay			4.3			
Intersection Capacity Utilization			38.9%	ICU Level of Service		A
Analysis Period (min)			15			

HCM Unsignalized Intersection Capacity Analysis  
5: Range Road 135 & North Access

2044 AM Peak - Senestivity PD Traffic  
07/26/2021



Movement	WBL	WBR	NBT	NBR	SBL	SBT
Lane Configurations						
Traffic Volume (veh/h)	20	0	0	145	0	0
Future Volume (Veh/h)	20	0	0	145	0	0
Sign Control	Stop		Free			Free
Grade	0%		0%			0%
Peak Hour Factor	0.92	0.92	0.92	0.92	0.92	0.92
Hourly flow rate (vph)	22	0	0	158	0	0
<b>Pedestrians</b>						
Lane Width (m)						
Walking Speed (m/s)						
Percent Blockage						
Right turn flare (veh)						
Median type	None			None		
Median storage veh						
Upstream signal (m)						
pX, platoon unblocked						
vC, conflicting volume	79	79			158	
vC1, stage 1 conf vol						
vC2, stage 2 conf vol						
vCu, unblocked vol	79	79			158	
tC, single (s)	6.7	6.5			4.4	
tC, 2 stage (s)						
tF (s)	3.8	3.6			2.5	
p0 queue free %	97	100			100	
cM capacity (veh/h)	859	909			1268	
<b>Direction, Lane #</b>	<b>WB 1</b>	<b>NB 1</b>	<b>SB 1</b>			
Volume Total	22	158	0			
Volume Left	22	0	0			
Volume Right	0	158	0			
cSH	859	1700	1700			
Volume to Capacity	0.03	0.09	0.00			
Queue Length 95th (m)	0.6	0.0	0.0			
Control Delay (s)	9.3	0.0	0.0			
Lane LOS	A					
Approach Delay (s)	9.3	0.0	0.0			
Approach LOS	A					
<b>Intersection Summary</b>						
Average Delay			1.1			
Intersection Capacity Utilization			19.5%	ICU Level of Service	A	
Analysis Period (min)			15			

HCM Unsignalized Intersection Capacity Analysis  
 1: Highway 58 & East Access





















2044 PM Peak - Senestivity PD Traffic  
 07/26/2021



Movement	EBL	EBT	WBT	WBR	SBL	SBR
Lane Configurations						
Traffic Volume (veh/h)	0	104	66	0	0	0
Future Volume (Veh/h)	0	104	66	0	0	0
Sign Control		Free	Free		Stop	
Grade		0%	0%		0%	
Peak Hour Factor	0.92	0.92	0.92	0.92	0.92	0.92
Hourly flow rate (vph)	0	113	72	0	0	0
<b>Pedestrians</b>						
Lane Width (m)						
Walking Speed (m/s)						
Percent Blockage						
Right turn flare (veh)						
Median type		None	None			
Median storage veh						
Upstream signal (m)						
pX, platoon unblocked						
vC, conflicting volume	72			185	72	
vC1, stage 1 conf vol						
vC2, stage 2 conf vol						
vCu, unblocked vol	72			185	72	
tC, single (s)	4.4			6.7	6.5	
tC, 2 stage (s)						
tF (s)	2.5			3.8	3.6	
p0 queue free %	100			100	100	
cM capacity (veh/h)	1368			744	917	
<b>Direction, Lane #</b>	<b>EB 1</b>	<b>WB 1</b>	<b>SB 1</b>			
Volume Total	113	72	0			
Volume Left	0	0	0			
Volume Right	0	0	0			
cSH	1368	1700	1700			
Volume to Capacity	0.00	0.04	0.00			
Queue Length 95th (m)	0.0	0.0	0.0			
Control Delay (s)	0.0	0.0	0.0			
Lane LOS			A			
Approach Delay (s)	0.0	0.0	0.0			
Approach LOS			A			
<b>Intersection Summary</b>						
Average Delay			0.0			
Intersection Capacity Utilization			9.1%	ICU Level of Service	A	
Analysis Period (min)			15			

HCM Unsignalized Intersection Capacity Analysis  
 3: Highway 88/Range Road 135 & Highway 58

2044 PM Peak - Senestivity PD Traffic  
 07/26/2021

												
Movement	EBL	EBT	EBR	WBL	WBT	WBR	NBL	NBT	NBR	SBL	SBT	SBR
Lane Configurations												
Traffic Volume (veh/h)	108	13	83	9	7	55	77	111	18	79	159	159
Future Volume (Veh/h)	108	13	83	9	7	55	77	111	18	79	159	159
Sign Control		Free			Free			Stop			Stop	
Grade		0%			0%			0%			0%	
Peak Hour Factor	0.92	0.92	0.92	0.92	0.92	0.92	0.92	0.92	0.92	0.92	0.92	0.92
Hourly flow rate (vph)	117	14	90	10	8	60	84	121	20	86	173	173
Pedestrians												
Lane Width (m)												
Walking Speed (m/s)												
Percent Blockage												
Right turn flare (veh)												
Median type		None			None							
Median storage (veh)												
Upstream signal (m)												
pX, platoon unblocked												
vC, conflicting volume	68			104			536	336	14	356	366	8
vC1, stage 1 conf vol												
vC2, stage 2 conf vol												
vCu, unblocked vol	68			104			536	336	14	356	366	8
tC, single (s)	4.4			4.4			7.4	6.8	6.5	7.4	6.8	6.5
tC, 2 stage (s)												
tF (s)	2.5			2.5			3.8	4.3	3.6	3.8	4.3	3.6
p0 queue free %	91			99			63	75	98	79	63	83
cM capacity (veh/h)	1373			1330			229	492	990	407	473	998
Direction, Lane #	EB 1	EB 2	EB 3	WB 1	WB 2	WB 3	NB 1	SB 1				
Volume Total	117	14	90	10	8	60	225	432				
Volume Left	117	0	0	10	0	0	84	86				
Volume Right	0	0	90	0	0	60	20	173				
cSH	1373	1700	1700	1330	1700	1700	356	576				
Volume to Capacity	0.09	0.01	0.05	0.01	0.00	0.04	0.63	0.75				
Queue Length 95th (m)	2.1	0.0	0.0	0.2	0.0	0.0	31.3	50.2				
Control Delay (s)	7.9	0.0	0.0	7.7	0.0	0.0	31.0	27.7				
Lane LOS	A			A			D	D				
Approach Delay (s)	4.2			1.0			31.0	27.7				
Approach LOS							D	D				
Intersection Summary												
Average Delay			20.9									
Intersection Capacity Utilization			46.0%			ICU Level of Service		A				
Analysis Period (min)			15									

HCM Unsignalized Intersection Capacity Analysis  
4: Range Road 135 & Phase 1 Access

2044 PM Peak - Senestivity PD Traffic  
07/26/2021



Movement	WBL	WBR	NBT	NBR	SBL	SBT
Lane Configurations						
Traffic Volume (veh/h)	255	10	20	250	10	130
Future Volume (Veh/h)	255	10	20	250	10	130
Sign Control	Stop		Free			Free
Grade	0%		0%			0%
Peak Hour Factor	0.92	0.92	0.92	0.92	0.92	0.92
Hourly flow rate (vph)	277	11	22	272	11	141
Pedestrians						
Lane Width (m)						
Walking Speed (m/s)						
Percent Blockage						
Right turn flare (veh)						
Median type			None	None		
Median storage veh						
Upstream signal (m)						
pX, platoon unblocked						
vC, conflicting volume	321	158		294		
vC1, stage 1 conf vol						
vC2, stage 2 conf vol						
vCu, unblocked vol	321	158		294		
tC, single (s)	6.7	6.5		4.4		
tC, 2 stage (s)						
tF (s)	3.8	3.6		2.5		
p0 queue free %	55	99		99		
cM capacity (veh/h)	613	819		1124		
<b>Direction, Lane #</b>						
	WB 1	NB 1	SB 1			
Volume Total	288	294	152			
Volume Left	277	0	11			
Volume Right	11	272	0			
cSH	619	1700	1124			
Volume to Capacity	0.47	0.17	0.01			
Queue Length 95th (m)	18.7	0.0	0.2			
Control Delay (s)	15.8	0.0	0.7			
Lane LOS	C		A			
Approach Delay (s)	15.8	0.0	0.7			
Approach LOS	C					
<b>Intersection Summary</b>						
Average Delay			6.3			
Intersection Capacity Utilization		39.6%		ICU Level of Service		A
Analysis Period (min)			15			

HCM Unsignalized Intersection Capacity Analysis  
5: Range Road 135 & North Access

2044 PM Peak - Senestivity PD Traffic  
07/26/2021



Movement	WBL	WBR	NBT	NBR	SBL	SBT
Lane Configurations						
Traffic Volume (veh/h)	129	0	0	19	0	0
Future Volume (Veh/h)	129	0	0	19	0	0
Sign Control	Stop		Free			Free
Grade	0%		0%			0%
Peak Hour Factor	0.92	0.92	0.92	0.92	0.92	0.92
Hourly flow rate (vph)	140	0	0	21	0	0
<b>Pedestrians</b>						
Lane Width (m)						
Walking Speed (m/s)						
Percent Blockage						
Right turn flare (veh)						
Median type	None			None		
Median storage veh						
Upstream signal (m)						
pX, platoon unblocked						
vC, conflicting volume	10	10			21	
vC1, stage 1 conf vol						
vC2, stage 2 conf vol						
vCu, unblocked vol	10	10			21	
tC, single (s)	6.7	6.5			4.4	
tC, 2 stage (s)						
tF (s)	3.8	3.6			2.5	
p0 queue free %	85	100			100	
cM capacity (veh/h)	942	995			1431	
<b>Direction, Lane #</b>	<b>WB 1</b>	<b>NB 1</b>	<b>SB 1</b>			
Volume Total	140	21	0			
Volume Left	140	0	0			
Volume Right	0	21	0			
cSH	942	1700	1700			
Volume to Capacity	0.15	0.01	0.00			
Queue Length 95th (m)	4.0	0.0	0.0			
Control Delay (s)	9.5	0.0	0.0			
Lane LOS	A					
Approach Delay (s)	9.5	0.0	0.0			
Approach LOS	A					
<b>Intersection Summary</b>						
Average Delay			8.3			
Intersection Capacity Utilization			17.5%	ICU Level of Service	A	
Analysis Period (min)			15			

# APPENDIX F:

## MCKENZIE COUNTY ROAD CROSS SECTION

# COLLECTOR ROAD

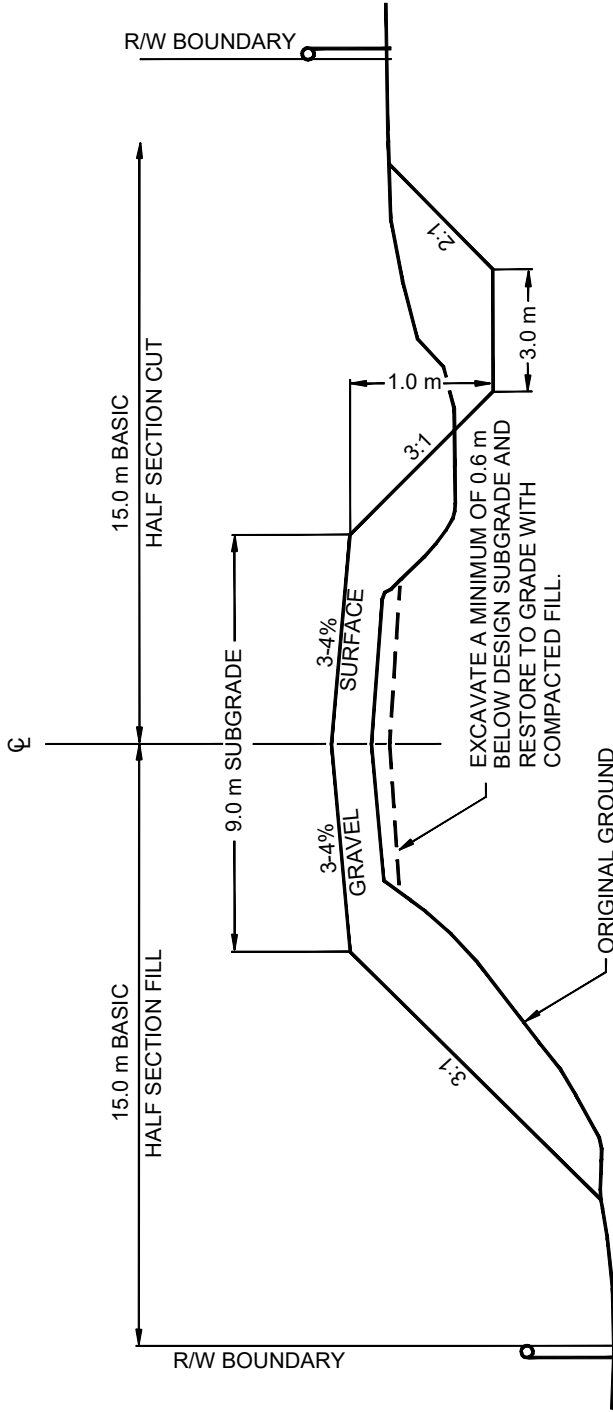

NOTE:  
 THIS STANDARD IS INTENDED FOR LOW VOLUME LOCAL ROADS THAT WILL BE GRAVEL SURFACED ONLY. TYPICALLY THIS 8.0 m ROADWAY IS FOR ROADS WITH AN AADT > 200.



**Fig. G - 04**

## MACKENZIE COUNTY GENERAL MUNICIPAL IMPROVEMENTS STANDARDS

TYPICAL CROSS-SECTION FOR GRADING & GRAVEL SURFACING (RLU-209G)

DATE:

DESIGN:

APPROVED:

FILE NO:

**SCALE: NTS**



**APPENDIX G:**  
**ILLUMINATION WARRANT**

# Illumination of Isolated Rural Intersections

## LIGHTING WARRANT SPREADSHEET

This spreadsheet is to be used in conjunction with *Illumination of Isolated Rural Intersections*, Transportation Association of Canada, February 2001.

Please enter information in the cells with yellow background

### INTERSECTION CHARACTERISTICS

Hwy 58	Main Road
Hwy 88	Minor Road
Mackenzie County	City/Town

Date	June 24, 2021
Other	2044 Post Development

### GEOMETRIC FACTORS

	Value	Rating	Weight	Comments	Check	Score
Channelization Rating	Descriptive	0		Refer to Table 1(A) to determine rating value	OK	
Presence of raised channelization? ( Y / N )	n				OK	
Highest operating speed on raised, channelized approach (km/h)	100		5		OK	
Channelization Factor					OK	0
Approach Sight Distance on most constrained approach (%)	100	0	10	Relative to the recommended minimum sight distance	OK	0
Posted Speed limit (in 10's of km/h)	100				OK	
Radius of Horizontal Curve (m)	T			Enter "T" for tangent (no horizontal curve at the intersection)	OK	
Posted Speed Category =		0				
Posted Speed Category =	B	0				
Posted Speed Category =		0				
Posted Speed Category =		0				
Horizontal Curvature Factor		0	5		OK	0
Angle of Intersection (10's of Degrees)	90	0	5		OK	0
Downhill Approach Grade (x.x%)	0.0	0	3	Rounded to nearest tenth of a percent	OK	0
Number of Intersection Legs	4	2	3	Number of legs = 3 or more	OK	6
<b>Geometric Factors Subtotal</b>						<b>6</b>

### OPERATIONAL FACTORS

Is the intersection signalized ? ( Y / N )	n			Calculate the Signalization Warrant Factor		
AADT on Major Road (2-way)	3600	3	10	Either Use the two AADT inputs <b>OR</b> the Descriptive Signalization Warrant (Unused values should be set to Zero) Refer to Table 1(B) for description and rating values for signalization warrant.	OK	30
AADT on Minor Road (2-way)	2000	4	20		OK	80
Signalization Warrant	Descriptive	0	30		OK	0
Night-Time Hourly Pedestrian Volume	0	0	10	Refer to Table 1(B), note #2, to account for children and seniors	OK	0
Intersecting Roadway Classification	Descriptive	2	5	Refer to Table 1(B) for ratings.	OK	10
Operating Speed or Posted Speed on Major Road (km/h)	100	4	5	Refer to Table 1(B), note #3	OK	20
Operating Speed on Minor Road (km/h)	100	4	5	Refer to Table 1(B), note #3	OK	20
<b>Operational Factors Subtotal</b>						<b>160</b>

### ENVIRONMENTAL FACTOR

Lighted Developments within 150 m radius of intersection	1	1	5	Maximum of 4 quadrants	OK	5
<b>Environmental Factor Subtotal</b>						<b>5</b>

### COLLISION HISTORY

Average Annual night-time collision frequency due to inadequate lighting (collisions/yr, rounded to nearest whole # )	1.0	1	15	Enter <b>either</b> the annual frequency (See Table 1(C), note #4) <b>OR</b> the number of collisions / MEV (Unused values should be set to Zero)	OK	15
Collision Rate over last 3 years, due to inadequate lighting (/MEV)	0	0	0		OK	0
Is the average ratio of all night to day collisions >= 1.5 (Y/N)	n	0			OK	
<b>Collision History Subtotal</b>						<b>15</b>

Check Intersection Signalization:  
Intersection is not Signalized

**ILLUMINATION WARRANTED**  
DELINEATION LIGHTING TO ILLUMINATE PEDESTRIANS OR  
CROSS STREET TRAFFIC

### SUMMARY

Geometric Factors Subtotal	6
Operational Factor Subtotal	160
Environmental Factor Subtotal	5
Collision History Subtotal	15

**TOTAL POINTS** **186**

# Illumination of Isolated Rural Intersections

## LIGHTING WARRANT SPREADSHEET

This spreadsheet is to be used in conjunction with *Illumination of Isolated Rural Intersections*, Transportation Association of Canada, February 2001.

Please enter information in the cells with yellow background

### INTERSECTION CHARACTERISTICS

Hwy 58	Main Road
Hwy 88	Minor Road
Mackenzie County	City/Town

Date	June 24, 2021
Other	2034 Post Development

### GEOMETRIC FACTORS

	Value	Rating	Weight	Comments	Check	Score
Channelization Rating	Descriptive	0		Refer to Table 1(A) to determine rating value	OK	
Presence of raised channelization? ( Y / N )	n				OK	
Highest operating speed on raised, channelized approach (km/h)	100		5		OK	
Channelization Factor					OK	0
Approach Sight Distance on most constrained approach (%)	100	0	10	Relative to the recommended minimum sight distance	OK	0
Posted Speed limit (in 10's of km/h)	100				OK	
Radius of Horizontal Curve (m)	T			Enter "T" for tangent (no horizontal curve at the intersection)	OK	
Posted Speed Category =		0				
Posted Speed Category =	B	0				
Posted Speed Category =		0				
Posted Speed Category =		0				
Horizontal Curvature Factor		0	5		OK	0
Angle of Intersection (10's of Degrees)	90	0	5		OK	0
Downhill Approach Grade (x.x%)	0.0	0	3	Rounded to nearest tenth of a percent	OK	0
Number of Intersection Legs	4	2	3	Number of legs = 3 or more	OK	6
<b>Geometric Factors Subtotal</b>						<b>6</b>

### OPERATIONAL FACTORS

Is the intersection signalized ? ( Y / N )	n			Calculate the Signalization Warrant Factor		
AADT on Major Road (2-way)	4000	3	10	Either Use the two AADT inputs <b>OR</b> the Descriptive Signalization Warrant (Unused values should be set to Zero) Refer to Table 1(B) for description and rating values for signalization warrant.	OK	30
AADT on Minor Road (2-way)	4000	4	20		OK	80
Signalization Warrant	Descriptive	0	30		OK	0
Night-Time Hourly Pedestrian Volume	0	0	10	Refer to Table 1(B), note #2, to account for children and seniors	OK	0
Intersecting Roadway Classification	Descriptive	2	5	Refer to Table 1(B) for ratings.	OK	10
Operating Speed or Posted Speed on Major Road (km/h)	100	4	5	Refer to Table 1(B), note #3	OK	20
Operating Speed on Minor Road (km/h)	100	4	5	Refer to Table 1(B), note #3	OK	20
<b>Operational Factors Subtotal</b>						<b>160</b>

### ENVIRONMENTAL FACTOR

Lighted Developments within 150 m radius of intersection	1	1	5	Maximum of 4 quadrants	OK	5
<b>Environmental Factor Subtotal</b>						<b>5</b>

### COLLISION HISTORY

Average Annual night-time collision frequency due to inadequate lighting (collisions/yr, rounded to nearest whole # )	1.0	1	15	Enter <b>either</b> the annual frequency (See Table 1(C), note #4) <b>OR</b> the number of collisions / MEV (Unused values should be set to Zero)	OK	15
Collision Rate over last 3 years, due to inadequate lighting (/MEV)	0	0	0		OK	0
Is the average ratio of all night to day collisions >= 1.5 (Y/N)	n	0			OK	
<b>Collision History Subtotal</b>						<b>15</b>

Check Intersection Signalization:  
Intersection is not Signalized

**ILLUMINATION WARRANTED**  
DELINEATION LIGHTING TO ILLUMINATE PEDESTRIANS OR  
CROSS STREET TRAFFIC

### SUMMARY

Geometric Factors Subtotal	6
Operational Factor Subtotal	160
Environmental Factor Subtotal	5
Collision History Subtotal	15

**TOTAL POINTS**      **186**

# Illumination of Isolated Rural Intersections

## LIGHTING WARRANT SPREADSHEET

This spreadsheet is to be used in conjunction with *Illumination of Isolated Rural Intersections*, Transportation Association of Canada, February 2001.

Please enter information in the cells with yellow background

### INTERSECTION CHARACTERISTICS

Hwy 58	Main Road
East Access	Minor Road
Mackenzie County	City/Town

Date	June 24, 2021
Other	2044 Post Development - East Access

### GEOMETRIC FACTORS

	Value	Rating	Weight	Comments	Check	Score
Channelization Rating	Descriptive	0		Refer to Table 1(A) to determine rating value	OK	
Presence of raised channelization? ( Y / N )	n				OK	
Highest operating speed on raised, channelized approach (km/h)	100		5		OK	
Channelization Factor					OK	0
Approach Sight Distance on most constrained approach (%)	100	0	10	Relative to the recommended minimum sight distance	OK	0
Posted Speed limit (in 10's of km/h)	80				OK	
Radius of Horizontal Curve (m)	T			Enter "T" for tangent (no horizontal curve at the intersection)	OK	
Posted Speed Category =		0				
Posted Speed Category =		0				
Posted Speed Category =	C	0				
Posted Speed Category =		0				
Horizontal Curvature Factor		0	5		OK	0
Angle of Intersection (10's of Degrees)	90	0	5		OK	0
Downhill Approach Grade (x.x%)	0.0	0	3	Rounded to nearest tenth of a percent	OK	0
Number of Intersection Legs	3	1	3	Number of legs = 3 or more	OK	3
<b>Geometric Factors Subtotal</b>						<b>3</b>

### OPERATIONAL FACTORS

Is the intersection signalized ? ( Y / N )	n			Calculate the Signalization Warrant Factor		
AADT on Major Road (2-way)	2000	2	10	Either Use the two AADT inputs <b>OR</b> the Descriptive Signalization Warrant (Unused values should be set to Zero) Refer to Table 1(B) for description and rating values for signalization warrant.	OK	20
AADT on Minor Road (2-way)	300	0	20		OK	0
Signalization Warrant	Descriptive	0	30		OK	0
Night-Time Hourly Pedestrian Volume	0	0	10	Refer to Table 1(B), note #2, to account for children and seniors	OK	0
Intersecting Roadway Classification	Descriptive	1	5	Refer to Table 1(B) for ratings.	OK	5
Operating Speed or Posted Speed on Major Road (km/h)	100	4	5	Refer to Table 1(B), note #3	OK	20
Operating Speed on Minor Road (km/h)	60	1	5	Refer to Table 1(B), note #3	OK	5
<b>Operational Factors Subtotal</b>						<b>50</b>

### ENVIRONMENTAL FACTOR

Lighted Developments within 150 m radius of intersection	1	1	5	Maximum of 4 quadrants	OK	5
<b>Environmental Factor Subtotal</b>						<b>5</b>

### COLLISION HISTORY

Average Annual night-time collision frequency due to inadequate lighting (collisions/yr, rounded to nearest whole # )	1.0	1	15	Enter <b>either</b> the annual frequency (See Table 1(C), note #4) <b>OR</b> the number of collisions / MEV (Unused values should be set to Zero)	OK	15
OR Collision Rate over last 3 years, due to inadequate lighting (/MEV)	0	0	0		OK	0
Is the average ratio of all night to day collisions >= 1.5 (Y/N)	n	0			OK	
<b>Collision History Subtotal</b>						<b>15</b>

Check Intersection Signalization:  
Intersection is not Signalized

LIGHTING IS NOT WARRANTED

### SUMMARY

Geometric Factors Subtotal	3
Operational Factor Subtotal	50
Environmental Factor Subtotal	5
Collision History Subtotal	15

<b>TOTAL POINTS</b>	<b>73</b>
---------------------	-----------

# Illumination of Isolated Rural Intersections

## LIGHTING WARRANT SPREADSHEET

This spreadsheet is to be used in conjunction with *Illumination of Isolated Rural Intersections*, Transportation Association of Canada, February 2001.

Please enter information in the cells with yellow background

### INTERSECTION CHARACTERISTICS

Hwy 58	Main Road
Hwy 88	Minor Road
Mackenzie County	City/Town

Date	June 24, 2021
Other	2044 Post Development

### GEOMETRIC FACTORS

	Value	Rating	Weight	Comments	Check	Score
Channelization Rating	Descriptive	0		Refer to Table 1(A) to determine rating value	OK	
Presence of raised channelization? ( Y / N )	n				OK	
Highest operating speed on raised, channelized approach (km/h)	100		5		OK	
Channelization Factor					OK	0
Approach Sight Distance on most constrained approach (%)	100	0	10	Relative to the recommended minimum sight distance	OK	0
Posted Speed limit (in 10's of km/h)	100				OK	
Radius of Horizontal Curve (m)	T			Enter "T" for tangent (no horizontal curve at the intersection)	OK	
Posted Speed Category =		0				
Posted Speed Category =	B	0				
Posted Speed Category =		0				
Posted Speed Category =		0				
Horizontal Curvature Factor		0	5		OK	0
Angle of Intersection (10's of Degrees)	90	0	5		OK	0
Downhill Approach Grade (x.x%)	0.0	0	3	Rounded to nearest tenth of a percent	OK	0
Number of Intersection Legs	4	2	3	Number of legs = 3 or more	OK	6
<b>Geometric Factors Subtotal</b>						<b>6</b>

### OPERATIONAL FACTORS

Is the intersection signalized ? ( Y / N )	n			Calculate the Signalization Warrant Factor		
AADT on Major Road (2-way)	7000	4	10	Either Use the two AADT inputs <b>OR</b> the Descriptive Signalization Warrant (Unused values should be set to Zero) Refer to Table 1(B) for description and rating values for signalization warrant.	OK	40
AADT on Minor Road (2-way)	5000	4	20		OK	80
Signalization Warrant	Descriptive	0	30		OK	0
Night-Time Hourly Pedestrian Volume	0	0	10	Refer to Table 1(B), note #2, to account for children and seniors	OK	0
Intersecting Roadway Classification	Descriptive	2	5	Refer to Table 1(B) for ratings.	OK	10
Operating Speed or Posted Speed on Major Road (km/h)	100	4	5	Refer to Table 1(B), note #3	OK	20
Operating Speed on Minor Road (km/h)	100	4	5	Refer to Table 1(B), note #3	OK	20
<b>Operational Factors Subtotal</b>						<b>170</b>

### ENVIRONMENTAL FACTOR

Lighted Developments within 150 m radius of intersection	1	1	5	Maximum of 4 quadrants	OK	5
<b>Environmental Factor Subtotal</b>						<b>5</b>

### COLLISION HISTORY

Average Annual night-time collision frequency due to inadequate lighting (collisions/yr, rounded to nearest whole # )	1.0	1	15	Enter <b>either</b> the annual frequency (See Table 1(C), note #4) <b>OR</b> the number of collisions / MEV (Unused values should be set to Zero)	OK	15
Collision Rate over last 3 years, due to inadequate lighting (/MEV)	0	0	0		OK	0
Is the average ratio of all night to day collisions >= 1.5 (Y/N)	n	0			OK	
<b>Collision History Subtotal</b>						<b>15</b>

Check Intersection Signalization:  
Intersection is not Signalized

**ILLUMINATION WARRANTED**  
DELINEATION LIGHTING TO ILLUMINATE PEDESTRIANS OR  
CROSS STREET TRAFFIC

### SUMMARY

Geometric Factors Subtotal	6
Operational Factor Subtotal	170
Environmental Factor Subtotal	5
Collision History Subtotal	15

**TOTAL POINTS** **196**

# APPENDIX H:

# SIGNALIZATION WARRANT ANALYSIS



## - Traffic Signal Warrant Analysis

Main Street (name)	Highway 58	Direction (EW or NS)	EW	Comments <b>Warrant analysis for 2044 Post Development scenario - Caribou Mtn</b>
Side Street (name)	Highway 88	Direction (EW or NS)	NS	
Quadrant / Int #	1			
CHECK SHEET				

Road Authority:	
City:	Calgary
Analysis Date:	2021 Jun 24, Thu
Count Date:	
Date Entry Format:	(yyyy-mm-dd)

Lane Configuration		Excl LT	Th & LT	Through	Th+RT+LT	Th & RT	Excl RT	Upstream Signal (m)	# of Thru Lanes
Highway 58	WB	1		1			1		1
Highway 58	EB	1		1			1		1
Highway 88	NB				1				
Highway 88	SB				1				

Demographics		
Elem. School/Mobility Challenged	(y/n)	n
Senior's Complex	(y/n)	n
Pathway to School	(y/n)	n
Metro Area Population	(#)	1,000
Central Business District	(y/n)	n

Other input		Speed (Km/h)	Truck %	Bus Rt (y/n)	Median (m)
Highway 58	EW	100	30.0%	n	0.0
Highway 88	NS	80	30.0%	n	0.0

Traffic Input	NB			SB			WB			EB			Ped1 NS	Ped2 NS	Ped3 EW	Ped4 EW
	LT	Th	RT	LT	Th	RT	LT	Th	RT	LT	Th	RT	W Side	E Side	N Side	S Side
	press 'Set Peak Hours' Button to set the peak hour periods	76	115	11	51	103	103	7	13	57	113	9	65	1	1	1
	76	115	11	51	103	103	7	13	57	113	9	65	1	1	1	1
	76	115	11	51	103	103	7	13	57	113	9	65	1	1	1	1
	76	115	11	51	103	103	7	13	57	113	9	65	1	1	1	1
	76	115	11	51	103	103	7	13	57	113	9	65	1	1	1	1
<b>Total (6-hour peak)</b>	<b>456</b>	<b>690</b>	<b>66</b>	<b>306</b>	<b>618</b>	<b>618</b>	<b>42</b>	<b>78</b>	<b>342</b>	<b>678</b>	<b>54</b>	<b>390</b>	<b>6</b>	<b>6</b>	<b>6</b>	<b>6</b>
<b>Average (6-hour peak)</b>	<b>76</b>	<b>115</b>	<b>11</b>	<b>51</b>	<b>103</b>	<b>103</b>	<b>7</b>	<b>13</b>	<b>57</b>	<b>113</b>	<b>9</b>	<b>65</b>	<b>1</b>	<b>1</b>	<b>1</b>	<b>1</b>

### Average 6-hour Peak Turning Movements

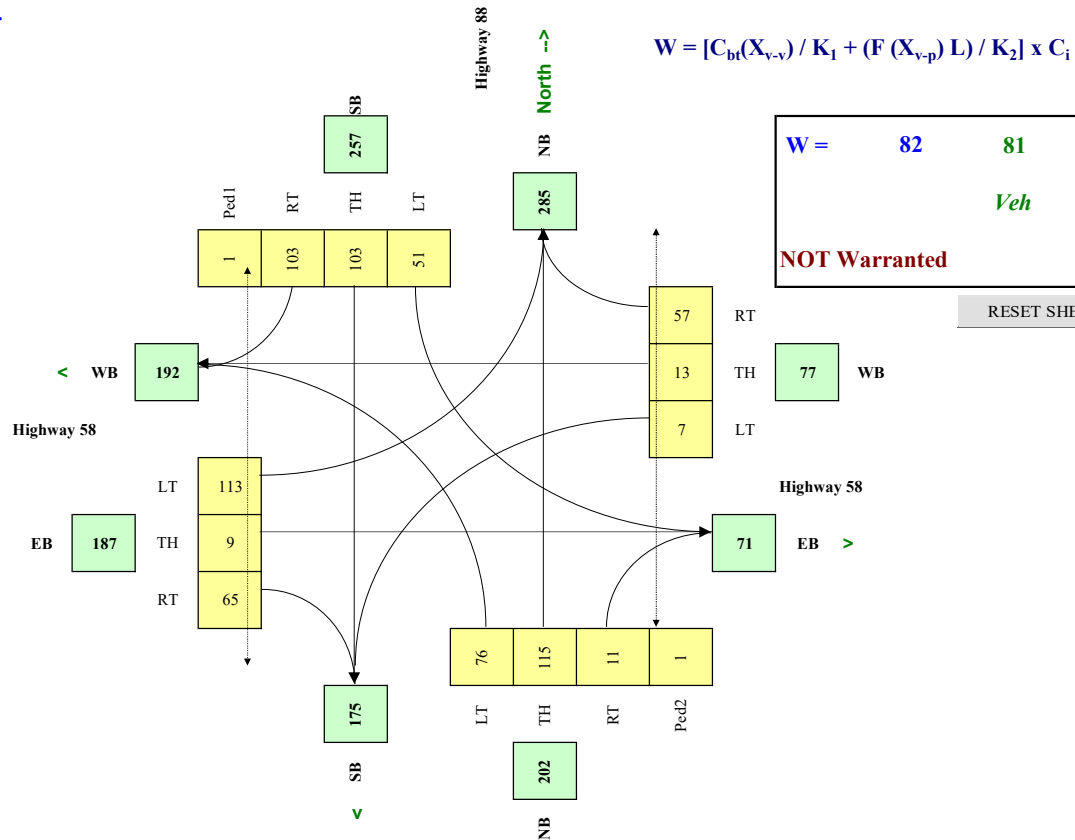

# APPENDIX I:

# SIGHT DISTANCE PROFILE



Graph: Min, Avg, Max Elevation: 303, 304, 307 m

Range Totals: Distance: 2.02 km Elev Gain/Loss: 1.00 m, -4.00 m Max Slope: 5.2%, -5.9% Avg Slope: 0.1%, -3.2%



Graph: Min, Avg, Max Elevation: 303, 304, 307 m

Range Totals: Distance: 2.02 km Elev Gain/Loss: 1.00 m, -4.00 m Max Slope: 5.2%, -5.9% Avg Slope: 0.1%, -3.2%



# Appendix B – Email Correspondence with MacKenzie County

## Bryan Gray

---

**From:** Caitlin Smith <csmith@mackenziecounty.com>  
**Sent:** November 25, 2021 9:35 AM  
**To:** Dale Palmer  
**Cc:** Theresa Shelton; Matt Slorstad; Dylan Smith; Bryan Gray  
**Subject:** RE: LRRCN Area Structure Plan

CAUTION: External Email.

Good morning Dale,

I am in agreeance that all the concerns have been addressed from the administrative perspective.

Thank you,

**Caitlin Smith | Manager of Planning and Development | Mackenzie County**

PO Box 640, 4511-46 Ave. | Fort Vermilion | AB | T0H 1N0

Main Line: 780.928.3983 | Fax: 780.928.3636

Toll Free: 1.877.927.0677 | Cell: 780.841.5529

[www.mackenziecounty.com](http://www.mackenziecounty.com)

---

**From:** Dale Palmer <dalep@lrrgroup.ca>  
**Sent:** November 23, 2021 2:25 PM  
**To:** Caitlin Smith <csmith@mackenziecounty.com>  
**Cc:** Theresa Shelton <theresa@lrrcn.ab.ca>; Matt Slorstad <mstorstad@urbansystems.ca>; Dylan Smith <dsmith@urbansystems.ca>; Bryan Gray <bgray@urbansystems.ca>  
**Subject:** RE: LRRCN Area Structure Plan

Good afternoon Caitlin

With reference to the storm pond, I do not believe there will be significant maintenance requirements. The pond will be seeded with a natural mix, and mowing will only be required on a occasional basis. As we have other areas that we will need to attend around this development we see as this as something we could maintain.

The control structure and outlet include a sump that should be checked and cleaned out as required. A dry hydrant is proposed for the pond which will need to be checked for operation on a occasional basis.

By the end of this week, can you please confirm to all parties that the County is in agreeance with the noted items so that we can have a updated ASP to you prior to December 7<sup>th</sup>.

Thanks kindly

Dale



**Dale Palmer CPA, CA**

Chief Financial Officer

Office: 587-758-6144

Mobile: 780-990-5255

Email: [dalep@lrrgroup.ca](mailto:dalep@lrrgroup.ca)

9402-114 Avenue, Building A  
High Level, AB T0H 1Z0

---

**From:** Caitlin Smith <[csmith@mackenziecounty.com](mailto:csmith@mackenziecounty.com)>

**Sent:** November 22, 2021 1:14 PM

**To:** Dale Palmer <[dalep@lrrgroup.ca](mailto:dalep@lrrgroup.ca)>

**Cc:** Theresa Shelton <[theresa@lrrcn.ab.ca](mailto:theresa@lrrcn.ab.ca)>; Matt Slorstad <[mstorstad@urbansystems.ca](mailto:mstorstad@urbansystems.ca)>; Dylan Smith <[dsmith@urbansystems.ca](mailto:dsmith@urbansystems.ca)>; Bryan Gray <[bgray@urbansystems.ca](mailto:bgray@urbansystems.ca)>

**Subject:** LRRCN Area Structure Plan

Good morning Dale,

Please note that your e-mail was sent to another Caitlin in the organization. Please send all correspondence regarding the ASP to [csmith@mackenziecounty.com](mailto:csmith@mackenziecounty.com).

I have read through your comments and to clarify number 4; do you believe there will be significant maintenance associated with the Storm Pond? Do you anticipate that it will be just mowing? Will there be an outlet, etc.?

Please send me that revised plan by December 7, 2021 at the latest.

Thank you,

**Caitlin Smith | Manager of Planning and Development | Mackenzie County**

PO Box 640, 4511-46 Ave. | Fort Vermilion | AB | T0H 1N0

Main Line: 780.928.3983 | Fax: 780.928.3636

Toll Free: 1.877.927.0677 | Cell: 780.841.5529

[www.mackenziecounty.com](http://www.mackenziecounty.com)



The information in this message is confidential and may be privileged, intended for the sole use of the addressee. If you are not the intended recipient of this message, any disclosure, copying, distribution or action taken or omitted in accordance with this message is prohibited. If you have received this communication in error, please destroy & delete from your computer immediately and notify us by email, fax or phone as per the above contact numbers.

## Bryan Gray

---

**From:** Dale Palmer <dalep@lrrgroup.ca>  
**Sent:** November 16, 2021 12:57 PM  
**To:** Caitlyn Froese  
**Cc:** Theresa Shelton; Matt Slorstad; Dylan Smith; Bryan Gray  
**Subject:** FW: URGENT: Fw: LRRCN Area Structure Plan

CAUTION: External Email.

Good Afternoon Caitlyn

Please see the below with regards to the questions and comments posed on your email of November 10<sup>th</sup>.

- 1) Currently the subdivision operationally has the Petro Canada and access road developed to the Cangas station. The Cangas station will primarily be used for heavy propane truck delivery and seldom used for any other means. As we will have equipment on site to do the parking lot of the Petro Canada and the laydown area, at this time, until further development occurs in the area, we do not feel that it would be much of a burden on the Petro Canada to ensure that the primary access road and road to the Cangas be taken on by the Petro Canada. We would need to open this conversation up further when the development goes into future stages, but for this coming season I do not see this as a concern.
- 2) As for Solid waste, we are only producing the amounts from the Petro-Canada site. Being a first Nation we are already looking at ways to reduce the impact of our imprint of which is primarily organic and cardboard. For any waste that needs to be hauled away, we agree to use the Regional landfill as part of this ASP.
- 3) With any development, infrastructure is assessed and installed in stages. As with this development as the traffic increases and Alberta Transportation or the County deem that it is necessary we would certainly want to have street lighting put in the development. We currently have not as it has not been a requirement of AT, but as the subdivision grows we will ensure that this is in the planning. Particularly as we either add residential or further commercial development. For example, the second phase of development will require partial delineation and will be our responsibility as the developer.
- 4) I am unsure of what is being requested regrading an alternative servicing plan for the storm facilities. Both the engineers of the development and the engineers of the Petro Canada have agreed upon the current storm water facilities, as required by Alberta Transportation. To restrict post-development discharge to pre-development conditions, storm facilities are necessary.
- 5) As for the future sale of lots, we are at the beginning stages and are only looking at having stage 2 underground and road servicing completed next year. There are currently no plans to sell or have any agreements with 3<sup>rd</sup> parties.
- 6) Though I am unsure why this concerns the ASP, as a update, the residential investment consists of possibly 12 residential units in Fort Vermillion. This is in on-going discussions with ISC. The proposal we have put forward currently looks quite favourably that it would be a go forward. Until the Minister has stamped funding approved we cannot confirm this would go forward.

If the responses above satisfy the County's concerns, please let me know as soon as possible and we will update and resubmit the ASP in time for the December 14<sup>th</sup> Public Hearing.

Should anything else arise regarding this ASP please cc all of the above parties.

Thank you

Dale



**Dale Palmer CPA, CA**

Chief Financial Officer

Office: 587-758-6144

Mobile: 780-990-5255

Email: dalep@lrrgroup.ca

9402-114 Avenue, Building A  
High Level, AB T0H 1Z0

---

**From:** Caitlin Smith <[csmith@mackenziecounty.com](mailto:csmith@mackenziecounty.com)>

**Sent:** Wednesday, November 10, 2021 4:50 PM

**To:** Theresa Shelton <[theresa@lrrcn.ab.ca](mailto:theresa@lrrcn.ab.ca)>

**Subject:** RE: LRRCN Area Structure Plan

Good afternoon Theresa,

I am sending you this email to inform you that Bylaw 1242-21 Caribou Mountain Area Structure Plan passed first reading yesterday.

Council has requested that the following concerns be addressed in the Area Structure Plan prior to Public Hearing as Council is divided on whether or not to endorse this proposal due to the following concerns:

- Road servicing within a new rural industrial subdivision requires a large maintenance commitment such as snow clearing, this will fall back on the County when service is already spread thin in rural areas.
- Solid waste from commercial and industrial sources should be hauled directly to the Regional Landfill rather than increasing the burden on waste transfer stations, which are intended for residential waste.
- The new intersection improvements will likely require street lighting in the future, perhaps this should be required of the developer now.
- An alternative servicing plan should be made for the storm water management facilities.

Is there anyway that LRRCN would maintain their own services such as snow clearing? Also, to haul waste to the landfill instead of using rural waste transfer stations?

The biggest concern of Council is that this new development may defer business opportunities away from Fort Vermilion. Will future industrial lots be available for anyone to purchase? Also, I know we had discussed some residential investment in Fort Vermilion, is this still a consideration?

Due to advertising deadlines, Council direction, and the time needed to make these changes if you so choose, this can be presented for Public Hearing on December 14, 2021.

